

CIRCUIT
CHECK

HOURS MINUTES SECONDS

13 4 0 24

MILLISECONDS

998.70

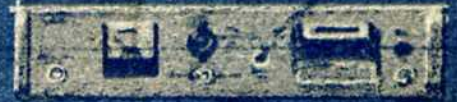
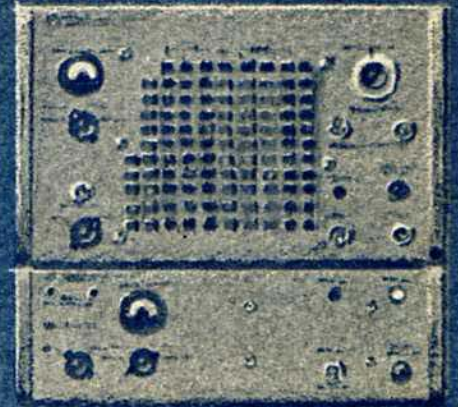
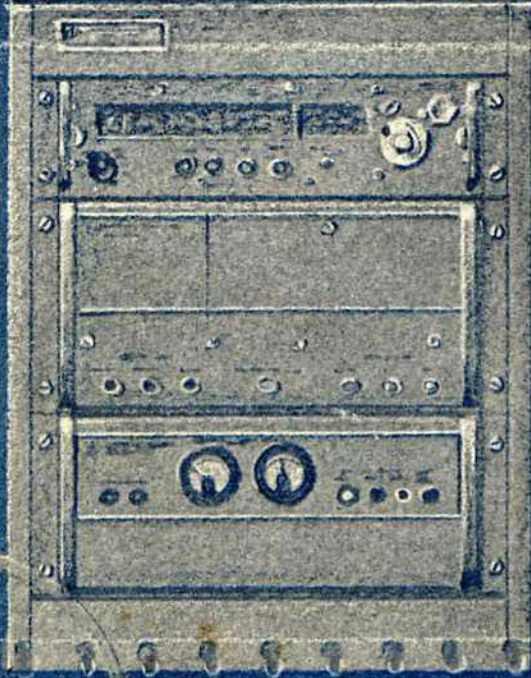

FREQUENCY AND TIME STANDARDS

 APPLICATION NOTE 52
HEWLETT PACKARD CO.



**FREQUENCY AND TIME
STANDARDS**

APPLICATION NOTE 52

FREQUENCY AND TIME DIVISION, PALO ALTO, CALIFORNIA

HEWLETT  PACKARD

Copyright HEWLETT-PACKARD COMPANY 1965
1501 PAGE MILL ROAD, PALO ALTO, CALIFORNIA, U.S.A.

TABLE OF CONTENTS

Section	Page
I	INTRODUCTION 1-1
	1. General 1-1
	2. Frequency Standards 1-1
	3. Timekeeping - Interval and Epoch 1-2
	4. Radio Time Signals 1-2
	5. Local Primary Standards 1-3
II	SYSTEM OPERATION, PRIMARY AND SECONDARY FREQUENCY AND TIME STANDARDS 2-1
	1. Introduction to Frequency Standards 2-1
	2. Primary Frequency Standards 2-1
	3. Secondary Frequency Standards 2-2
	4. Time Standards 2-3
	5. Frequency Dividers and Clocks 2-3
	6. VLF Comparison System 2-7
	7. Time Record with VLF Comparator 2-16
	8. Power Supply Considerations 2-17
	9. In-Plant Distribution of Standard Frequencies 2-17
	10. Precision Variable Frequency Source 2-17
III	METHODS FOR PRECISE FREQUENCY STANDARD INTERCOMPARISONS 3-1
	1. General 3-1
	2. Oscilloscope Lissajous Patterns 3-1
	3. Oscilloscope Pattern Drift 3-2
	4. Direct Frequency Comparison with a Counter 3-2
	5. Direct Counter Readout of Frequency Error 3-3
	6. Phase Noise Modulation Measurements 3-4
IV	TIME DETERMINATION. 4-1
	1. Introduction 4-1
	2. Computation of the Great-Circle Distance 4-2
	3. Transmission Modes 4-4
	4. Relation of Time Errors to Frequency Drift. 4-6
	5. Frequency Determination from Time Comparisons 4-9
V	STABILITY AND SPECTRAL PURITY IN FREQUENCY STANDARDS 5-1
	1. General 5-1
	2. Factors Affecting Stability 5-1
	3. Techniques for Obtaining Spectral Purity 5-1
	4. Quartz Oscillators 5-2

TABLE OF CONTENTS (Cont'd)

APPENDIX I - TIME	AI-1
1. Introduction	AI-1
2. Apparent Solar Time	AI-1
3. Mean Solar Time	AI-1
4. Universal Time	AI-2
5. Sidereal Time	AI-2
6. Mean Sidereal Time	AI-4
7. Ephemeris Time	AI-4
8. Atomic Time	AI-4
9. U. S. Standard Time	AI-5
10. Time Zones	AI-5
APPENDIX II - NATIONAL STANDARDS OF TIME & FREQUENCY	AII-1
1. NBS Boulder	AII-1
2. United States Frequency Standard	AII-1
3. United States Time Unit	AII-2
4. Agreement with Ephemeris Time	AII-2
5. NBS Broadcasts	AII-2
6. Time Signal offsets for WWV and WWVH	AII-2
APPENDIX III - STANDARD FREQUENCY & TIME SIGNAL BROADCASTS	AIII-1
1. Introduction	AIII-1
2. NBS Frequency and Time Services	AIII-1
3. U. S. Navy Broadcasts	AIII-5
4. Worldwide Frequency and Time Broadcasts	AIII-5
APPENDIX IV - NOMOGRAPHS AND TABLES (for great-circle determination)	AIV-1
APPENDIX V - DEFINITIONS	AV-1
APPENDIX VI - HEWLETT-PACKARD INSTRUMENTS FOR FREQUENCY AND TIME STANDARD APPLICATIONS	AVI-1
BIBLIOGRAPHY	i

SECTION I

INTRODUCTION

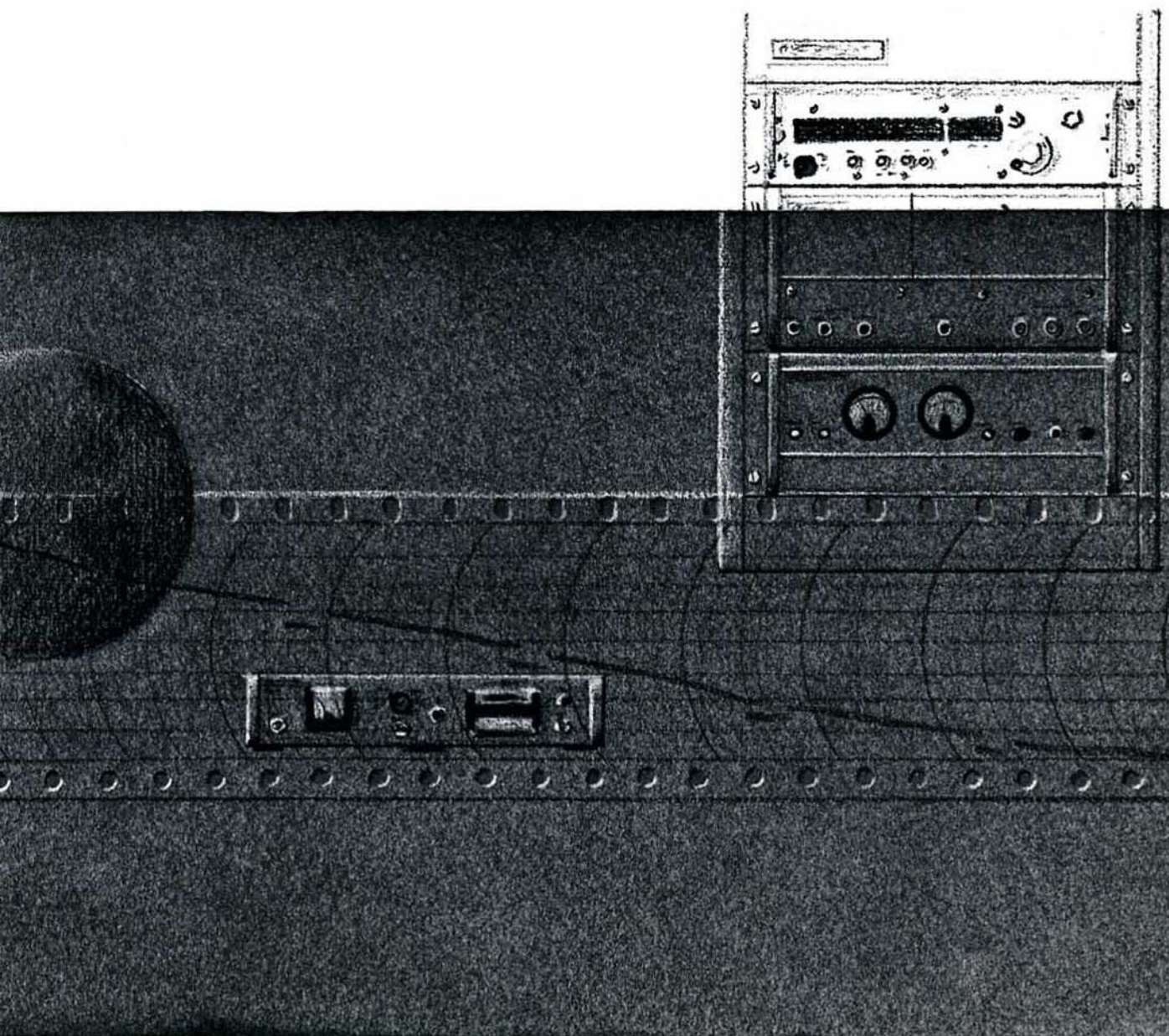

SECTION I

INTRODUCTION

1. GENERAL

This application note explains the principles of precision frequency and time standards, with emphasis on practical working methods of frequency and time determination.

Hewlett-Packard has placed major emphasis on the development of high performance frequency and time standards to meet the needs of basic research and advanced technology since 1943, when the first HP crystal-controlled frequency standard was produced. Today, the HP cesium beam standard typifies the state of the most advanced frequency and timekeeping art. This primary standard takes advantage of a most significant development, the utilization of an atomic transition to provide an interval of far greater uniformity than any previously available in the long history of timekeeping. This compact and portable self-contained unit has been flown as a "passenger" on regularly scheduled airlines around the world to compare time-of-day standards of the United States to those of other countries. The 1965 flight successfully compared standards to an accuracy of about one microsecond for the U.S., Switzerland, and several other countries.

Hewlett-Packard frequency and time standard systems are used for frequency and time control or calibration at manufacturing plants, physical research laboratories, calibration centers, astronomical observatories, missile and satellite tracking stations and radio monitoring and transmitting stations. System applications include the following: distributed standard frequencies in factories or research facilities ("house standards"), control of standard frequency and time broadcasts, synchronization of electronic navigation systems, investigation of radio transmission phenomena, frequency synthesizer control and adjustment of single-sideband communications equipment.

Because units of time or frequency cannot be kept in a vault for reference purposes, frequency and time standards require regular comparisons to a recognized primary standard to maintain their accuracy. Hewlett-Packard offers frequency and time standard systems which not only provide locally generated frequencies and time intervals, but also include means for relating these frequencies and time intervals to frequency/time standards such as the United States Frequency Standard (USFS).

While accuracy may be the primary concern, the degree to which a high-accuracy system is useful is a direct function of system reliability. For this reason, increased accuracy and increased reliability are considered inseparable design objectives at Hewlett-Packard. Necessary equipment characteristics provided by Hewlett-Packard systems are: (1) suitable oscillator stability, (2) high-accuracy comparison capability, (3) reliability and (4) operational simplicity.

Compatible design of HP's complete range of equipment makes it easy to arrange a system to meet the user's exact needs, whether they be for frequency standard work, timekeeping, or both. This application note explains basic system arrangements after a brief introduction to frequency and time standards, and to timekeeping. Appendices provide detailed information on precise timekeeping, on national standards of time and frequency maintained by NBS, and on worldwide broadcasts of time and frequency standards.

2. FREQUENCY STANDARDS

Frequency and time standard broadcast stations make possible worldwide comparisons of local standards to national standards. In the United States, the National Bureau of Standards operates standards stations, and the U. S. Navy operates transmitters that are frequency stabilized.

Fast and precise frequency calibrations traceable to the U. S. Frequency Standard (USFS) are possible through comparisons of a local standard against phase-stable low frequency standard signals now being transmitted by the National Bureau of Standards (NBS). These low frequency broadcasts from NBS transmitters at Ft. Collins, Colorado, WWVB (60 kHz) and WWVL (20 kHz) are capable of yielding comparison precisions as high as a few parts in 10^{12} against the U. S. Frequency Standard (in the continental U. S. under good propagation conditions). USFS, which is located at the Boulder, Colorado laboratories of NBS, is described in Appendix II.

Even at great distances, the frequency comparison accuracy which can be achieved over 24 hours with low frequencies exceeds that which could be realized by use of high frequency transmissions over months. Other low frequency transmissions include the U. S. Navy Station NBA (24.0 kHz, Canal Zone) and the United Kingdom Station GBR (16.0 kHz, Rugby).

The stability of the local standard is a primary consideration in achieving a high level of accuracy and precision. An increase in a local standard's long term stability makes it possible to increase the length of time between recalibrations.

A new level of absolute accuracy is now possible in a local standard system which incorporates atomic controlled oscillators such as the HP 5060A Cesium Beam Frequency Standard. The cesium standard provides an accuracy of 2 parts in 10^{11} .

The HP cesium beam standard uses an invariant atomic frequency to stabilize a high quality quartz oscillator, thus combining the excellent short-term characteristics of a quartz oscillator with the long-term stability of an atomic resonator. The long-term stability for

the HP 5060A is 1 part in 10^{11} and short-term stability approaches 1.5×10^{-11} for a 1 sec averaging time (long-time constant used for all conditions).

Long-term stability of Hewlett-Packard quartz oscillators is rated conservatively 5 parts in 10^{10} per day for Models 107AR, BR and 5 parts in 10^{11} per day for Models 106A, B, and substantially better performance is experienced under normal operating conditions. Such performance results from use of (a) carefully tested, high-quality crystal, (b) precision temperature control, (c) inherently stable circuitry, and (d) low power dissipation in the crystal [approximately 0.7 microwatt in the 5 MHz crystal (107AR, BR) and 0.2 microwatt in the 2.5 MHz crystal (106A, B)].

In addition to good long and short-term stability, many applications also require a signal having a high spectral purity. This is essential where frequency multiplication to microwave frequencies is performed. The HP 106A, B and 107AR, BR were designed to specifically include these applications.

3. TIMEKEEPING - INTERVAL AND EPOCH

Timekeeping has two distinct aspects: determination of epoch and determination of interval. Epoch is concerned with when an event occurred; interval is concerned with the unit of time and is independent of a starting point.

For measurement purposes, an accurate time scale is set up in the same way as an accurate length scale. From a chosen origin point, a constant unit is laid off until the resulting scale extends over the interval of interest. That the unit be consistent is critical to the scale's internal accuracy.

The search for a uniform time unit has led to adoption of an atomic standard as was done for the unit of length (the meter is defined in terms of wavelengths of the orange-red line of krypton-86). The fundamental unit of time used in the U. S. is the international second. The 1964 redefinition of the second, in terms of a certain hyperfine transition in the Cs-133 atom, has realized a time scale more uniform than any previous scale. Until 1964, the time unit was based upon astronomical observations.

The time of day is another matter. Time-of-day (epoch) is measured in terms of a scale, Universal Time (UT), based upon the earth's rotation. The UT scale is not uniform because the earth's rotation is not uniform. Nonetheless, people find it practical to base their everyday timekeeping on the sunrise-sunset cycle (mean solar day), despite its inconsistencies. Further, the epoch of Universal Time is the one employed for technological applications involving the rotational position of the earth, such as navigation by sea or air and the tracking of satellites. Universal Time corrected both for observed polar motion and for seasonal variation is designated UT₂.

Secular or irregular variations persist in Universal Time even when corrections have been made to arrive at UT₂. To avoid the slight non-uniformity of UT₂,

astronomers adopted in 1956 a scale known as Ephemeris Time, based upon the motion of the earth about the sun during the year 1900. Although the Ephemeris Second is now being superseded by the Atomic Second, no change in the size of the unit is involved because the second of atomic time was deliberately chosen to agree as closely as experimentally possible with the earlier unit.

The Master Clock of the U. S. Naval Observatory, Washington, D. C., determines Standard Time for the United States. Standard Time differs from nominal UT₂ by an integral number of hours. The Naval Observatory determines Universal Time and Ephemeris Time from astronomical observations, and publishes data which enable seven different kinds of time used in scientific work to be obtained.

A sketch of the complex relationships of the various time scales and their interesting historical background is included in Appendix I.

4. RADIO TIME SIGNALS

By its nature, time interval is not a standard which can be kept in a vault for reference purposes. Regular comparison to a recognized primary standard is a necessity.

Radio transmissions provide both time-of-day or epoch and time interval. The U. S. National Bureau of Standards and the U. S. Navy broadcast time signals from many stations including WWVB, WWV, WWVH and NBA (refer to Appendix III for details).

By international agreement, Universal Time Signals are synchronized to about one millisecond and are maintained to within about 100 milliseconds of UT₂.

Time signals from WWVB are exactly one (atomic) second apart, while those from WWV and WWVH are slightly longer to keep in accord with UT₂. Phase adjustments are made periodically to the WWVB signal to keep time pulses within about 100 milliseconds of the variable UT₂ scale.

If radio wave energy were propagated at a constant velocity and with a noise-free background, frequency and time signals could be received with essentially the stability and accuracy of the primary source. Frequency would be received just as sent and time signals would have a constant delay depending on distance from source for which a simple correction could be applied.

The actual propagation does not realize these ideal conditions, so systems must be designed to overcome existing limitations insofar as possible.

The high and low frequency ranges have different characteristics because of the way these signals travel around the globe. High frequency signals propagate in a complex manner between the ionosphere and the earth to arrive at distant points. Variations of the ionosphere's ionic profile and height above earth cause the propagation time of a signal to change continuously. Instabilities of high frequency propagation

make it necessary to record data from stations such as WWV for many days to average out the propagation anomalies and even approach a precision better than 1 part in 10^8 , although WWV signals are considered to be stable to 5 parts in 10^{11} as transmitted.

Low frequency and very low frequency signals are far more stable. They follow the earth's curvature, in effect being guided as though by a duct having the ionosphere as its top surface. Since the ionosphere acts as a boundary rather than as a direct reflector, its variations have a much reduced influence. The high phase stability and long range coverage of the lower frequencies makes them valuable for standard frequency transmissions.

Where precise timekeeping is of paramount importance, most users still rely upon a high frequency service, for example, WWV. Information bandwidth characteristics have limited to some extent the use of lower frequencies for time-of-day information and for time comparison measurements. To achieve high precision in clock synchronization, sharply rising pulses are needed to serve as precise time markers. At the lower frequencies, pulse rise time is degraded by the time constants of the antenna systems and the receiving equipment. Improvement in the ability to synchronize accurately from VLF time signals is expected, however, as work continues in government and industry on equipment and techniques.

5. LOCAL PRIMARY STANDARDS

To those standards laboratories and industrial plants where the requirement is ultraprecise frequency and time standards, the HP cesium beam frequency standard offers a new level of stability and precision in a compact and portable unit. Its accuracy, 2 parts in 10^{11} , is exceeded only by that of the hydrogen

maser, which is larger and more costly. The cesium beam standard is a self-calibrating primary standard with excellent long-term stability.

A single precisely-known frequency is the basis for a time standard clock, provided that the frequency remains uniform and the clock can be properly set initially and operates without interruption. To properly set a local clock initially, it must be correlated with the master clock of the system (for U. S. Standard Time, that of the U. S. Naval Observatory).

Precise time synchronization at great distances has been the subject of much study. Radio broadcasts provide worldwide time signals to an accuracy of about one millisecond. Radio propagation time uncertainties make it difficult to improve very much upon this value, except by use of a specialized service such as the U. S. Navy's Loran-C. This navigation service makes possible microsecond synchronizations in the area served by the East Coast Chain.

Two additional ways found to achieve microsecond accuracies are by use of satellites and by use of airplanes to transport accurate clocks. The satellite Relay II was used in early 1965 to relate clocks in the United States and Japan (see Section IV). Preliminary results from this experiment show that synchronizations to microsecond accuracies are possible at satellite ground stations. In a 1965 experiment, the Hewlett-Packard "flying clock" (a 5060A cesium beam unit and a 115BR clock, see Section IV) correlated time over intercontinental distances to microsecond accuracies. A time closure to within one microsecond for a 23-day period was made with an NBS standard at Boulder, Colorado.

Portability of the HP 5060A now makes it possible to correlate distant stations to microsecond accuracies.

SECTION II

**SYSTEM OPERATION,
PRIMARY AND SECONDARY
FREQUENCY STANDARDS**

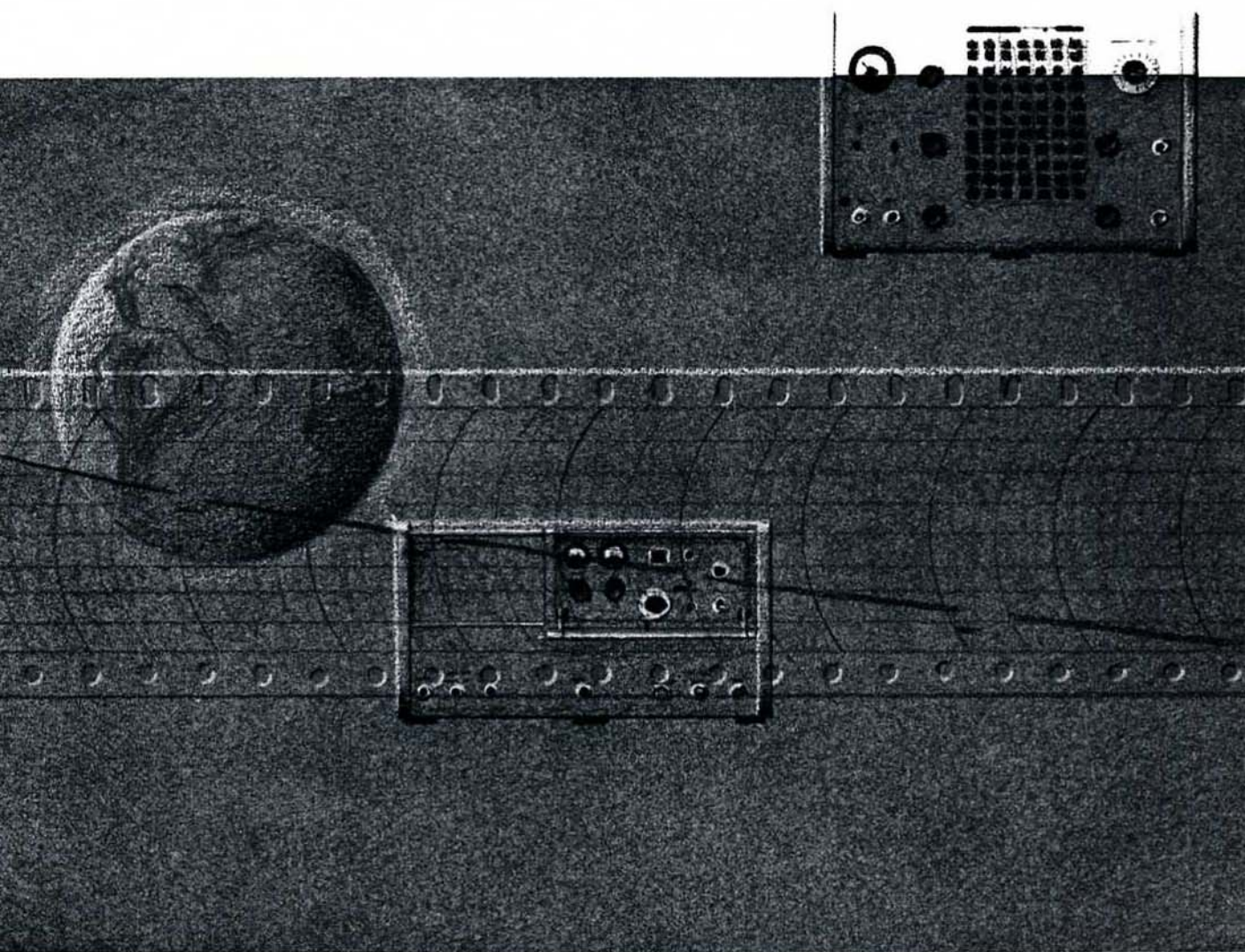

SECTION II

SYSTEM OPERATION

PRIMARY AND SECONDARY FREQUENCY AND TIME STANDARDS

1. INTRODUCTION TO FREQUENCY STANDARDS

The demand continues for ever greater precision and accuracy in frequency control. Basic to such control is the atomic standard with unprecedented frequency stability. The cesium and hydrogen atomic standards are truly primary frequency standards and require no other reference for calibration.

Atomic resonance standards use quantum mechanical effects in the energy states of matter, particularly transitions between states separated by energies corresponding to microwave frequencies. Transitions having properties well suited to standards use occur in atoms of cesium, rubidium, thallium, and hydrogen. Considerable attention has been directed to three devices: the cesium atomic beam, the rubidium buffer gas cell, and the hydrogen maser. The cesium and rubidium devices utilize passive atomic resonators to steer conventional oscillators, usually of the quartz crystal type, via feedback control circuits. The hydrogen maser, an active device, derives its signal from stimulated emission of microwave energy amplified by electronic means to a useful power level.

Three other devices of interest as frequency standards are the thallium beam, the ammonia maser, and the rubidium maser. The ammonia maser is attractive because of the high spectral purity and excellent short-term stability it offers, but its development has not reached the stage of widespread use in general frequency control applications. The thallium beam, similar to the cesium beam standard, seems capable of even higher precision than cesium and is being investigated at the present time. The rubidium maser is a recent development which offers the prospect of spectral purity exceeding that of any existing atomic frequency standard.

Secondary frequency standards are those which must be referenced to an accepted source such as a primary standard. Quartz crystal oscillators are widely used as high quality secondary standards. Both the cesium beam and the rubidium cell devices make use of slaved quartz crystal oscillators. For applications not requiring the precision and accuracy available in a quartz crystal oscillator referred directly to a primary atomic standard, quartz oscillators referred to the U. S. Frequency Standard by means of phase comparisons with low frequency radio signals from WWVB or WWVL offer high accuracy at moderate cost.

For example, the HP Model 117A VLF Comparator phase compares a local frequency standard against the 60 kHz signal received via NBS station WWVB. A self-contained strip chart recorder plots the phase difference of the two frequencies, thus providing a link between house frequency standards and the USFS.

2. PRIMARY FREQUENCY STANDARDS

Common to all atomic frequency standards are means for (1) selecting atoms in a certain energy state, (2) enabling long lifetimes in that state, (3) exposing these atoms to (microwave) energy, and (4) detecting the results. Two primary atomic standards which have reached a high state of development are the hydrogen maser and the cesium beam.

A. THE HYDROGEN MASER

The hydrogen maser is a primary frequency standard in that it provides a frequency which is well defined without reference to any external standard. A system with the high Q needed to generate such a frequency results when arrangements are made to allow a relatively long interaction time between atoms in a selected energy state and a microwave field in a manner leading to maser action.

Hydrogen atoms are formed into a beam and passed through a magnetic field of high gradient to select those atoms in the higher quantum mechanical energy states, among which are the useful atoms in the state $F=1, m_F=0$. The selected atoms pass into a quartz cell having a protective coating that neither adsorbs hydrogen nor causes unwanted energy transitions to occur. A microwave field surrounds the cell. Within it, the atoms make random transits, reflecting from the walls. Their zig-zag path lengthens possible interaction time, and they interact with the microwave field until they relax either by giving their energy usefully to the field or through some (unwanted) collision event. The long interaction time permits coherent stimulation of the hydrogen atoms and sustained maser oscillations.

The hydrogen maser is potentially capable of extremely high stability, and existing units have reached stabilities to parts in 10^{13} over months.*

B. THE CESIUM BEAM STANDARD

Cesium beam standards are in use wherever high precision and accuracy in frequency and time standards are the goals; in fact, cesium beam units are the present basis for the U. S. Frequency Standard.

For the cesium beam standard, the quantum effects of interest arise in the nuclear magnetic hyperfine ground state of the atoms. A particularly appropriate transition occurs between the ($F=4, m_F=0$) \leftrightarrow ($F=3, m_F=0$) hyperfine levels in the cesium-133 atom, arising from electron-spin nuclear-spin interaction. This transition is appropriate for frequency control by reason of its relative insensitivity to external influences such as electric and magnetic fields and of its convenient frequency (in the microwave range, 9192+ MHz).

*Frequency, 2, 4, July-August 1964, p. 33.

A typical atomic beam device which takes advantage of this invariant transition is so arranged that cesium atoms (in all sub-levels of states $F=3$ and $F=4$) leave an oven, are formed into a beam, and are deflected in a non-uniform magnetic field ("A" field) by a vector component dependent upon m_F and the field. For the two $m_F=0$ states the deflection is equal and opposite. The atoms then pass through a low and uniform magnetic field space ("C" field) and are subject to excitation by microwave energy. At resonance, change of state occurs by absorption or by stimulated emission depending on the initial state, $F=3$ or $F=4$. Upon crossing a second magnetic field ("B" field) identical to the first one, those atoms and only those atoms which have undergone transitions are focused on the first element of a detector, a hot wire. The cesium atoms, ionized by the hot wire, are attracted to the first dynode of an electron multiplier. The resulting amplified current serves to regulate the frequency of an external crystal oscillator. Oscillator output is multiplied and fed back into the cesium beam through a waveguide, closing the loop.

In the HP Model 5060A Cesium Beam Standard, the microwave field, derived from a precision quartz oscillator by frequency multiplication and synthesis, is phase modulated at a low audio rate. When the microwave frequency deviates from the center of atomic resonance, the current from the electron multiplier contains a component alternating at the modulation rate with amplitude proportional to the frequency deviation and with phase information which indicates the direction, that is, whether the frequency lies above or below center frequency. This component is then filtered, amplified, and synchronously detected to provide a dc voltage used to automatically tune the quartz oscillator to zero error.

The control circuit provides a continuous monitoring of the output signal. Automatic logic circuitry is arranged to present an indication of correct operation. The new, compact cesium beam tubes exhibit frequency perturbations so small that independently constructed tubes compare within a few parts in 10^{12} . Outstanding reliability is obtained from these tubes with a presently guaranteed life of 10,000 hours.

The quartz crystal oscillator used exhibits superior characteristics even without control by the atomic resonator. Drift rate is less than 5×10^{-10} per 24 hours, and short-term stability is better than $\pm 1.5 \times 10^{-11}$ for a one second averaging time. The 5-MHz quartz crystal is housed in a two-stage proportionally-controlled oven. Output variation due to temperature is less than $\pm 1 \times 10^{-10}$ from 0° to 40°C .

C. FREQUENCY COMPARISON OF H MASER AND Cs STANDARD

A high precision measurement of the ratio of the frequencies of a hydrogen maser and a Hewlett-Packard Model 5060A Cesium Beam Standard has

shown the average zero-field hydrogen maser frequency to be:*

$$1,420,405,751.778 \pm 0.16 \text{ Hz}$$

The measurement was made at the Laboratoire Suisse des Recherches Horlogeres (LSRHO) in Neuchatel, Switzerland. Another measurement compared the LSRHO cesium long-beam tube against the hydrogen maser with similar results.**

3. SECONDARY FREQUENCY STANDARDS

A. QUARTZ OSCILLATORS

The striking properties of the quartz crystal oscillator give it such an advantage over all earlier frequency stable systems, such as those relying on tuning fork resonators, that its use for exacting measurements of frequency and time quickly became almost universal in national and industrial laboratories around the world.

Crystalline quartz has great mechanical and chemical stability and a small elastic hysteresis (which means that just a small amount of energy is required to sustain oscillation, hence frequency is only very slightly affected by variable external conditions). These are most useful in a frequency standard. The piezoelectric properties of quartz make it convenient for use in an oscillator circuit. When quartz and certain other crystals are stressed, an electric potential is induced in nearby conductors; conversely, when such crystals are placed in an electric field they are deformed a small amount proportional to field strength and polarity. This property by which mechanical and electrical effects are linked in a crystal is known as the piezoelectric effect.

In use, a quartz resonator is mounted between conducting electrodes, now often thin metallic coatings deposited directly on the crystal by evaporation. Mechanical support is provided at places on the crystal chosen to avoid any inhibition of the desired vibration, and if possible, such that unwanted vibration modes are suppressed. An alternating voltage applied across the crystal causes it to vibrate at a frequency such that mechanical resonance exists within the crystal.

When the resulting two-terminal resonator is connected into a circuit it behaves as though it were an electrical network. It is so located in the oscillator circuit that its equivalent electrical network becomes a major part of the resonant circuit that controls oscillator frequency.

*Peters, Holloway, Bagley, Cutler, "Hydrogen Maser and Cesium Beam Tube Frequency Standards Comparison", *Applied Physics Letters* 6, 2 (15 Jan. 65, p. 34).

**Adjacent paper by Peters and Kartaschoff, "Hydrogen Maser Frequency Comparison with Swiss Cs Atomic Beam Standard". See also Markowitz, et al, *Physical Review Letters*, Vol. 11, No. 7, (1 Oct. 63) p. 338.

Improvements in quartz crystal oscillator stability have come along three main avenues: (1) increased precision in temperature control, (2) improved cutting, mounting, and sealing techniques, and (3) improved control to keep driving power to the crystal low and constant.

An inherent characteristic of crystal oscillators is that their resonant frequency changes (usually increases) as they age. This "aging rate" of a well-behaved oscillator is almost constant. After the initial aging period, a few days to a month, the rate can be taken to be constant with but slight error. Once the rate is measured, it is usually easy to apply corrections to remove its effect from data. Over a long period, the accumulated error drift could amount to a serious error. (For example, a unit with drift rate of 1 part in 10^{10} per day could accumulate in a year an error of several parts in 10^8 .) Thus, periodic frequency checks and corrections are needed to maintain a quartz crystal frequency standard.

At Hewlett-Packard, long-term stability of the Model 106A/B Quartz Oscillator is conservatively rated at 5 parts in 10^{11} per day, and substantially better performance is experienced under normal operating conditions. Such exceptional stability results from careful attention to all controllable factors such as selection of the highest quality crystals, their operation in precision temperature controlled ovens, and their incorporation into inherently stable circuits designed for low power dissipation within the crystal.

B. RUBIDIUM VAPOR STANDARD.

The rubidium vapor standard, as is the case for the cesium beam, uses a passive resonator to stabilize a quartz oscillator. The Rb standard offers excellent short term stability in a relatively small apparatus easily made portable. It is a secondary standard because it must be calibrated against a primary standard such as the cesium beam during construction; it is not self-calibrating.

Operation of the rubidium standard is based on a hyperfine transition in Rb-87. The rubidium vapor and an inert buffer gas (to reduce Doppler broadening, among other purposes) are contained in a cell illuminated by a beam of filtered light. A photo detector observes changes near resonance in the amount of light absorbed as a function of applied microwave frequencies. The microwave signal is derived by multiplication of the oscillator frequency. A servo loop connects the detector output and oscillator such that the oscillator is locked to the center of the resonance line.

By an optical pumping technique, an excess population is built up in one of the Rb-87 ground-state hyperfine levels within the cell: the population of the F=2 level is increased at the expense of that of the F=1 level. The illuminated Rb-87 atoms are optically excited into upper energy states from which they decay into both the F=2 and the F=1 levels. The exciting light has been filtered to remove components linking the F=2 level to the upper energy states. Since the

light therefore excites atoms out of the F=1 level only, while they decay into both, an excess population builds up in the F=2 level. The optical absorption coefficient is reduced because fewer atoms are in the state where they can absorb the light.

Application of microwave energy, corresponding to that which separates the two ground state hyperfine levels F=2 and F=1, induces transitions from the F=2 to F=1 level with the result that more light is absorbed. In a typical system arrangement, photo-detector output reaches a minimum when the microwave frequency corresponds to the Rb-87 hyperfine transition frequency (approximately 6835 MHz).

Resonance frequency is influenced by the buffer gas pressure and to a lesser degree by other effects as well. For this reason, a Rb vapor standard must be calibrated against a primary standard. Once the cell is adjusted and sealed, the frequency remains highly stable.

4. TIME STANDARDS

Time standards and frequency standards have no fundamental differences -- they are based upon dual aspects of the same phenomenon. The reciprocal of time interval is frequency.

As a practical matter, a standard of frequency can serve as the basis for time measurement, and vice-versa, with certain restrictions. To avoid errors when a frequency standard is used to maintain time, either interval or epoch, care must be taken to reference the frequency to the time scale of interest (atomic, sidereal, UT_2 - see Appendix I).

The first requirement for a time standard is an ultrastable oscillator capable of producing an accurate, precise frequency. Such an oscillator can be made the basis of a clock.

When two independent oscillators are made to drive clocks, then the time kept is only as accurate as the frequency. Suppose two quartz oscillators with a known relative stability of about 10 parts in 10^{11} are used to drive clocks. In a day, the two clocks could accumulate a relative error of nearly $10 \mu s$. Even when the same frequency is used to drive two identical clocks, they might show two different times unless initially one had been set against the other to high precision.

To maintain a practical time standard, then, places additional requirements on top of those associated with maintaining a frequency standard.

5. FREQUENCY DIVIDERS AND CLOCKS

A. INTRODUCTION TO TIME COMPARISON SYSTEMS

In order to maintain a consistent local system of time and frequency standards, they must be inter-compared. Further, to keep the local system in correspondence with national standards, a reference must be established and maintained. Radio broadcasts from frequency and time standard stations are most often used as the link to keep this reference.

Many of the same qualities that make a quartz crystal controlled oscillator an excellent frequency standard are required for its use in a clock. The lower frequency convenient for clock operation must be derived from the high quartz frequency (typically, 0.1 MHz to 5 MHz) in a way that does not degrade its high precision and accuracy. This is normally accomplished by fail-safe regenerative divider circuits in the "Frequency Divider and Clock".

This section will describe equipment and methods used to compare a local system with standard broadcast signals for timekeeping purposes. Such comparisons can provide detailed records of drift rate as well as time or frequency differences between oscillators in the local system. Details of methods for comparisons against WWV (see Appendix III) to maintain a local system to Universal Time are given.

An LF/VLF system for maintaining local frequency standards traceable to the U. S. Frequency Standard is discussed in Section II Part 6.

B. HF RADIO RECEPTION

General characteristics of high frequency and lower frequency propagation were discussed in Section I-4 where it was pointed out that high frequency signal propagation is subject to erratic variations, in particular, phase delays. For effective use of HF timing signals, it is important that certain precautions be observed to reduce the effect of these variations. For best results:

- 1) Schedule observation for an all-daylight or all-night transmission path between transmitter and receiver. Avoid twilight hours.
- 2) Choose the highest reception frequency which provides consistent reception.
- 3) Observe tick transmission for a few minutes to judge propagation conditions. The best measurements are made on days when signals show little jitter or fading. If erratic conditions seem to exist, indicated by considerable fading and jitter in tick timing, postpone the measurement. Ionospheric disturbances causing erratic reception sometimes last less than an hour, but may last several days.
- 4) Make time comparison measurements using the ticks with the earliest consistent arrival time.

A good communications-quality receiver which can be tuned to the needed frequencies (for WWV, 2.5, 5, 10, 15, 20, and 25 MHz) is the basic requirement. The receiver's capability and complexity (hence cost) depend upon the degree of precision demanded of the measurement and upon the received signal strength at the user's location. It is preferable that the antenna be of the directional type, oriented to favor that transmission mode which consistently provides the shortest propagation path.

C. TIME COMPARISON BY TICK PHASING ADJUSTMENT

Figure 2-1 shows a block diagram for a system to compare local time against time signals from a standard station such as WWV. The local frequency

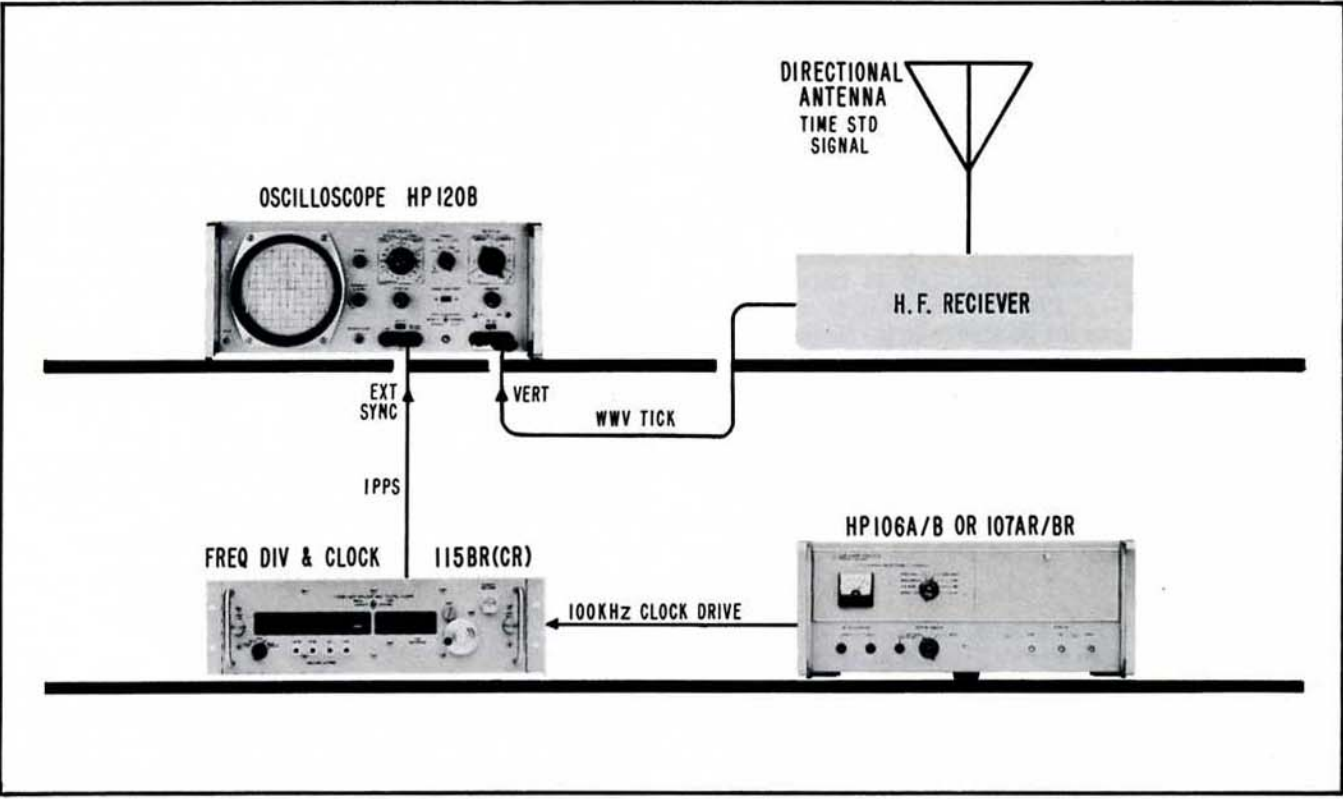

Figure 2-1. Equipment for time comparison with tick phasing adjustment

standard, an HP quartz oscillator (Model 107AR, BR or 106A, B, etc.) drives the frequency divider and clock (HP Model 115BR or CR). The 115BR/CR derives a 1 sec tick from the oscillator output, and it is these local ticks which are caused to trigger the sweep of the oscilloscope.

Upon initial observation, the local tick and the received tick, which is the master timing pulse, may be apart as much as a half second. With oscilloscope sweep time set at 1 sec or more, the WWV tick may be located with reference to the local tick. Adjustment of the Time Reference Control on the 115BR/CR is made to bring the WWV tick toward the beginning of the oscilloscope trace. Successive adjustments of the Time Reference Control and oscillator sweep speed are made until the two ticks are brought to near coincidence (the Time Reference Control operates to change the phase of the 115BR/CR tick without affecting oscillator frequency).

The WWV tick is a 5 ms pulse of a 1000 Hz signal (shown in Appendix III). It is this master timing pulse which is observed on the oscilloscope as the phasing of the local clock tick is shifted.

Once the two ticks have been brought into near coincidence, the calibrated Time Reference Control, which can be read to an accuracy of better than $\pm 10 \mu s$, gives the initial time reference between local time and the time of WWV. At this point the Time

Reference Control reading is logged. As the oscillator under test drifts with respect to the received time signals, the Time Reference Control is re-adjusted to again establish near coincidence with the WWV tick. The amount of this readjustment (which indicates the time drift of the local oscillator) is again logged. These data, taken over a period of time and plotted, will allow accurate determination of drift rate and frequency error. Time comparisons made over several days can yield comparison accuracies of a few parts in 10^8 or better. Oscillator frequency can be readjusted to keep within the desired accuracy limits.

The oscillograms of Figure 2-2 show the appearance of typical WWV signals (as received at Palo Alto, California with severe amplitude fading) on an HP Model 120B Oscilloscope during a time comparison measurement. Note that in oscillogram (D) the WWV tick starts about 3.2 ms after the time of sweep triggering. The time read from the 115BR/CR Time Reference Control in this instance is 3.2 ms ahead of the received WWV tick.

The time of day can be printed out in divisions as small as 1 ms when a HP 562A Digital Recorder is used with a Model 115BR/CR Frequency Divider and Clock modified for BCD time of day output. This output is derived from shaft angle encoders to give hours, minutes and seconds, and decade scalers may be added if milliseconds are wanted.

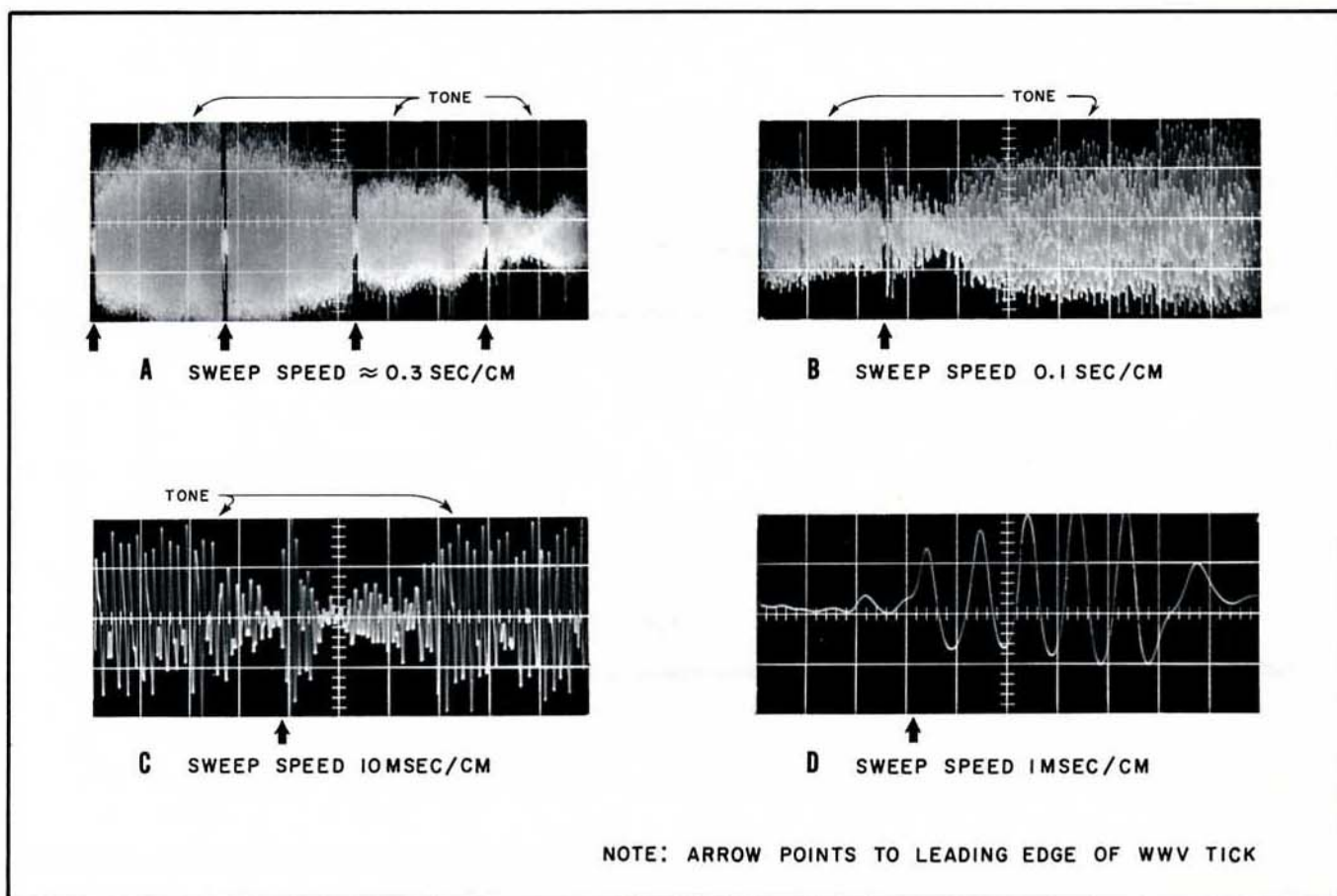

Figure 2-2. Typical oscillograms showing WWV signals

D. HF MEASUREMENTS WITH A TIME COMPARATOR

Systems which include the HP Model 114BR Time Comparator permit clock tick and other outputs to remain on-time during the time comparison measurement. The comparator permits a controlled delay to be generated after the clock tick output. The measurement procedure is similar to the basic procedure described already but is simplified by comparator-generated time marks supplied to the oscilloscope and by direct-reading delay dials on the comparator. Figure 2-3 shows the equipment.

During operation, the comparator switches which adjust oscilloscope sweep time and comparator delay are set to give a convenient oscilloscope presentation of the WWV tick. Comparator delay dials always indicate the delay between the clock tick and the start (left end) of the oscilloscope sweep. The time interval between the clock tick and the selected reference point on the WWV tick is equal to the 114BR delay dial reading plus the interval between the start of the oscilloscope sweep and the reference point on the WWV tick as indicated by the intensity-modulated time marks. Figure 2-4 illustrates use of the time marks to make possible a more accurate comparison measurement.

The WWV tick appears to be relatively free of jitter, and readings can easily be made to within $10 \mu\text{s}$ by switching to 1-ms sweep time. Only one cycle on the WWV tick appears on the oscilloscope at this sweep speed. As shown in Figure 2-4, intensity markers occur at intervals of 0.1 ms along the base line of the sweep. The $10\text{-}\mu\text{s}$ dashes on the waveform start at even 0.01 ms intervals, and spaces start at odd 0.01 ms intervals.

E. PHOTOGRAPHIC TICK AVERAGING

Since random variations in the radio propagation path cause variation in the arrival time of each WWV tick, the accuracy of time-comparison measurements depends to a large extent on the ability of the operator to judge the time of tick arrival. Excellent results can be obtained with a photographic averaging technique using an HP Model 196B Oscilloscope Camera or equivalent. A time exposure of several seconds produces an oscillogram from which the time of earliest consistent tick arrival can easily be determined. If the oscilloscope sweep time is accurately calibrated, the location of the tick reference point on the oscillogram can be adjusted to the chosen oscilloscope reference point to determine the time-comparison reading. Figure 2-5 shows several examples of time-exposure oscillograms using this technique.

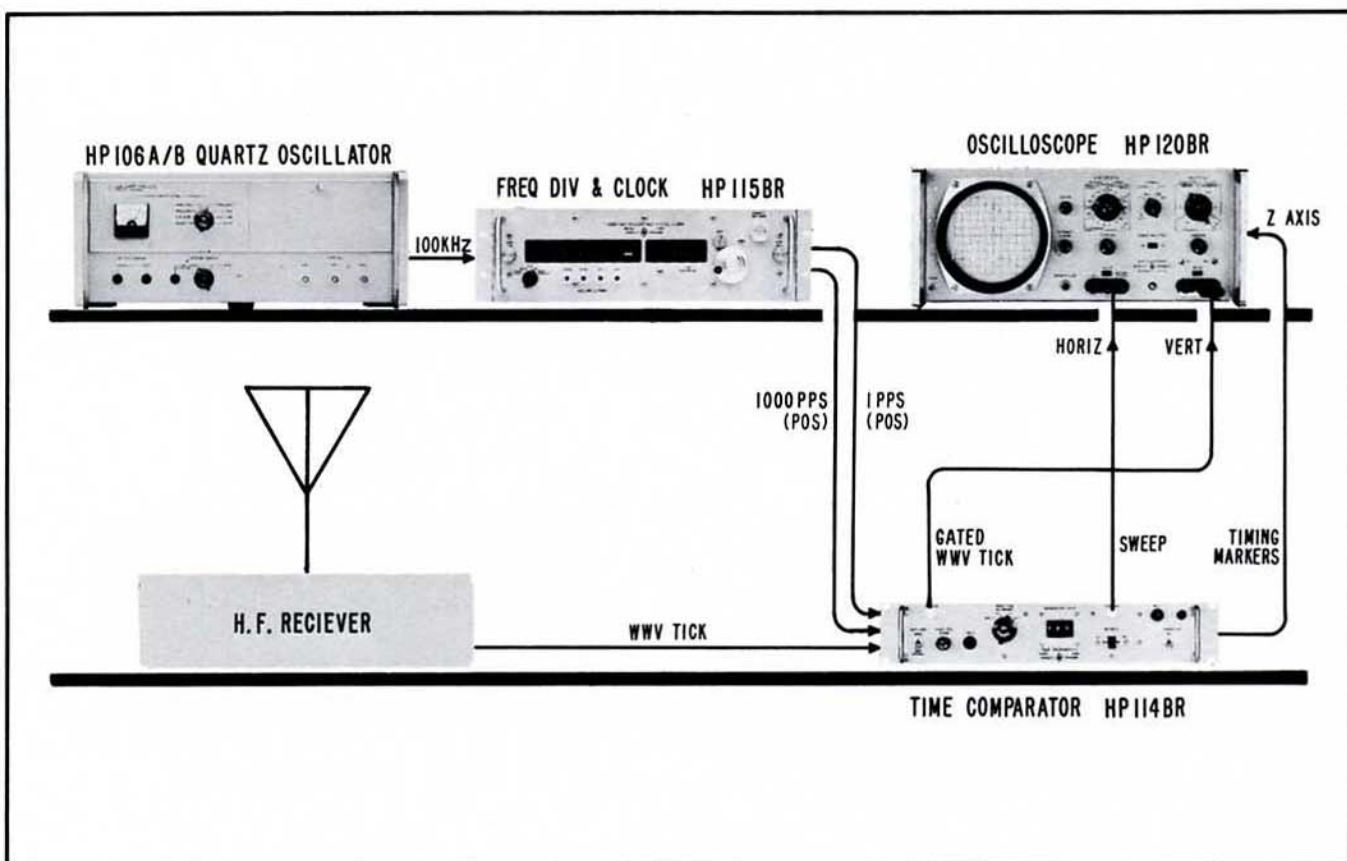
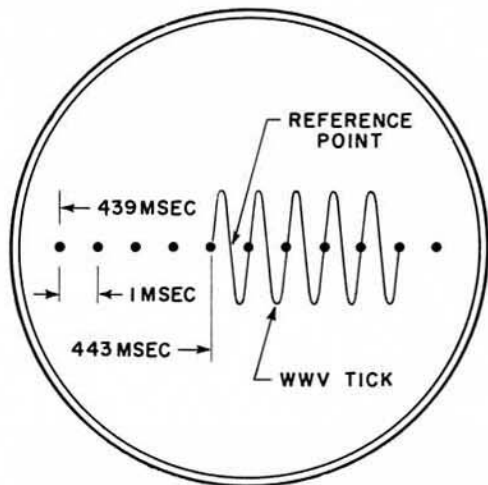
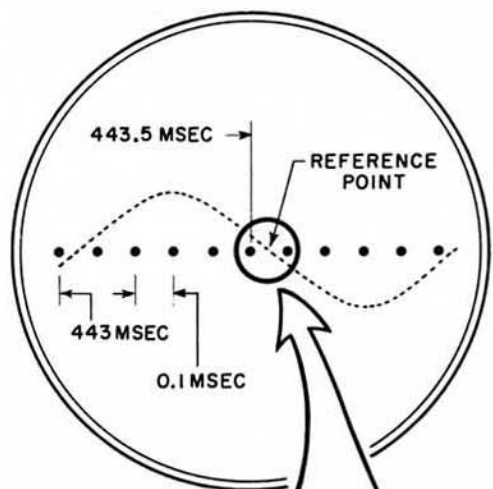

Figure 2-3. Equipment for time comparison simplified by use of HP-114BR Time Comparator

A SWEEP TIME SWITCH: 1MSEC
MILLISECONDS DELAY SWITCHES: 443MSEC



B SWEEP TIME SWITCH: 10MSEC
MILLISECONDS DELAY SWITCHES: 443MSEC



ENLARGED VIEW OF WAVEFORM

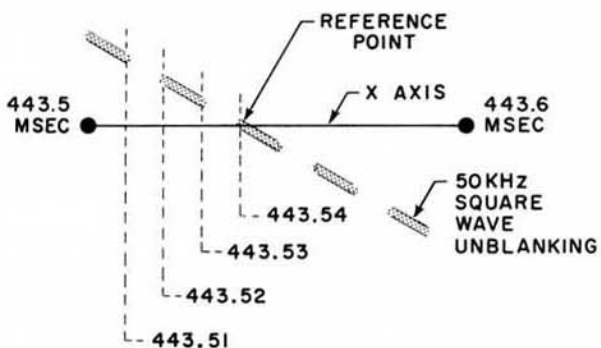

Figure 2-4. Waveform interpretation using Time Comparator

6. VLF COMPARISON SYSTEM

A. GENERAL

A local frequency standard can be maintained to within a part in 10^{10} or better by comparison of its relative phase to that of a received VLF carrier. Any one of a number of monitoring systems may be chosen to make this comparison possible, depending on the degree of precision required of the relative phase measurement. For the greatest precision, the local standard must have a low drift which is predictable to within a few parts in 10^{10} over several days.

If no better than a part in 10^8 is wanted, a nearly instantaneous direct comparison for a short time may be used. If a part in 10^9 is wanted, comparison must be continued for long enough to reveal any ionospheric disturbance. While low frequency signals are relatively immune to propagation variations, best results usually are obtained when the total propagation path is in sunlight and conditions are stable. Near sunrise and sunset there are noticeable shifts both in amplitude and in phase.

Design objectives for a receiver to make possible frequency standards traceable to NBS and the USFS include (1) performance at any location within the U.S. (2) simplicity of operation, (3) reliability, and (4) calibration accuracy capability approaching 5×10^{-11} on a daily basis. Hewlett-Packard has met these objectives with a VLF comparison system described in paragraph C.

B. LF/VLF RADIO RECEPTION

Propagation of low frequency and very low frequency signals has been discussed in Section I-4. The phase stability and long range coverage of lower frequency transmissions makes them particularly valuable for standard frequency broadcasts.

Variations in propagation conditions do, however, exist and for accurate comparison measurements account must be taken of such variations as those associated with the diurnal shift (phase shifts occurring at sunrise and sunset). Factors affecting path phase velocity include ionospheric conditions, ground conductivity, and surface roughness. Recent VLF propagation studies are summarized in a paper (a bibliography is included) presented at the General Assembly of URSI, held in Tokyo, Japan, September 1963.*

Since the phase velocity of long range VLF signals depends to an extent upon the effective height of the ionosphere, sudden atmospheric disturbances such as those occurring during solar flare events cause sudden phase anomalies. Other changes in VLF propagation are believed to relate to polar cape events, magnetic activity, nuclear explosions, and even to meteor showers.

*D.D. Crombie and A.G. Jean, "The Guided Propagation of ELF and VLF Radio Waves Between the Earth and the Ionosphere", *NBS Journal of Research*, 68D, 5, May 1964 (p. 584). See also "VLF Signals: Sunrise and Sunset Fading", *NBS Technical News Bulletin*, Feb. 1965 (p. 32).

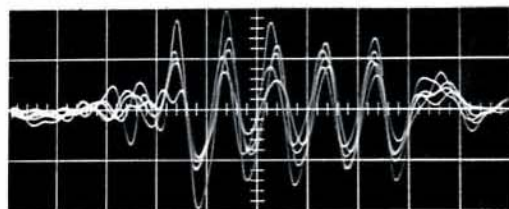

A FIVE SWEEPS WWV

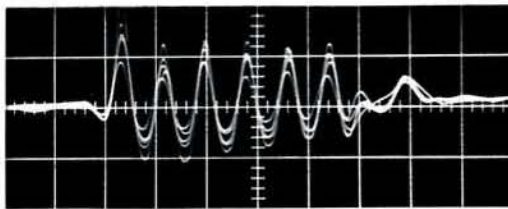

B FIVE SWEEPS WWVH

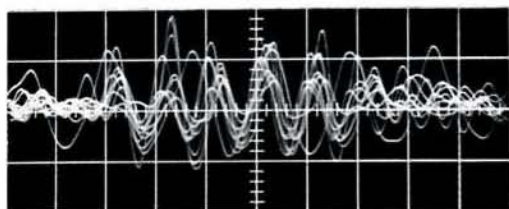

C TEN SWEEPS WWV

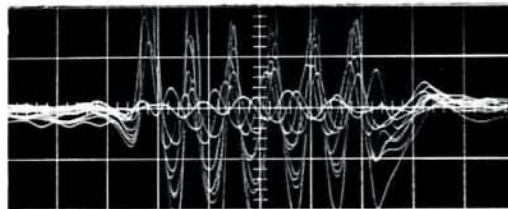

D TEN SWEEPS WWVH

Figure 2-5. Photographic tick averaging

Because relatively short periods serve for LF/VLF phase comparisons, diurnal phase shifts and other anomalies are not a serious problem, provided the user is aware of them.

C. HP-117A VLF COMPARATOR

The Hewlett-Packard VLF Comparator (Model 117A) provides for phase comparison between the 60 kHz signal from NBS station WWVB and a local frequency standard. Such comparisons serve for calibrating high quality frequency standards or for monitoring atomic frequency standards. The VLF Comparator thus provides a link between house frequency standards and the USFS.

In the continental U. S., frequency standard comparisons to an accuracy of a part in 10^{10} can be approached in an 8-hr period. A 24-hour period may give 2 parts in 10^{11} , and a 30-day period may give accuracies of parts in 10^{12} . The local standard being calibrated must, of course, be of a quality commensurate with the realization of such high accuracies.

NBS station WWVB at Ft. Collins, Colorado, is phase-locked to the USFS (described in Appendix II) and is kept to within a tolerance limit of $\pm 2 \times 10^{-11}$. The WWVB carrier frequency is referenced to the atomic second rather than to the second of Universal Time (Appendix II gives details).

The VLF Comparator* is a complete system (exclusive of local standard). The unit phase tracks a voltage-controlled oscillator with WWVB. The local frequency standard is then compared to the phase tracking oscillator. The comparator's strip chart recorder makes a continuous recording of the phase difference, measured in μ s. Figure 2-6 shows a simplified block diagram of the system (full details are given in the operating manual and will not be covered here).

In operating the VLF Comparator, the user should always consider the system as a whole: (1) transmitted signal, (2) transmission path, (3) VLF Comparator, and (4) local standard. The first two parts of the system are not under the user's control, so he must choose his observation time when a frequency standard signal is being transmitted and when transmission conditions are optimum. He should keep up to date on the NBS low frequency services by requesting that he be placed on the NBS mailing list (see Appendix III).

Antenna location and orientation are important. Best location is on the roof of a building on the side facing Ft. Collins, Colorado. The antenna should clear by

*Dexter Hartke, "A VLF Comparator for Relating Local Frequency to U.S. Standards", *Hewlett-Packard Journal*, Vol. 16, No. 2, Oct., 1964.

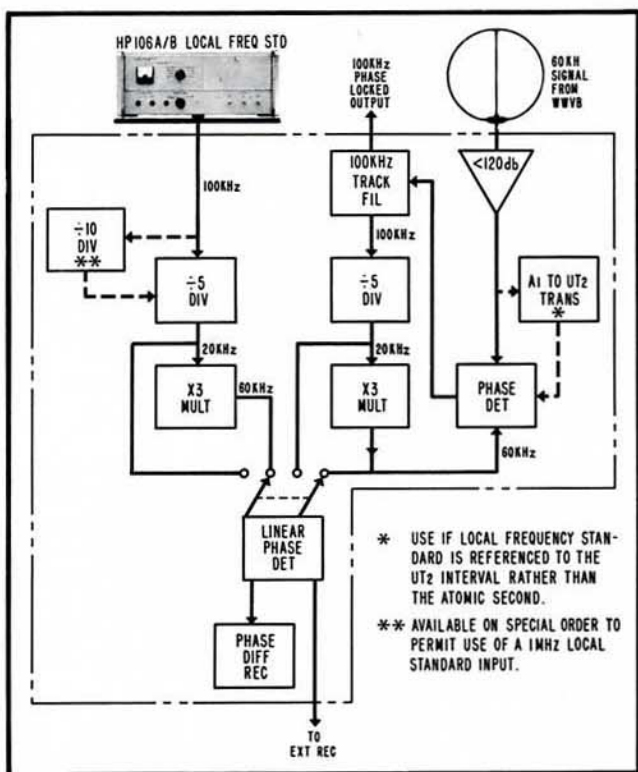

Figure 2-6. Simplified Diagram of the HP Model 117A VLF Comparator System

3 feet or more any metal structure, roof, etc. To avoid regeneration, the antenna should be at least 25 feet from the Model 117A. No appreciable signal deterioration has been found at distances of 1000 feet or more. The orientation shown in Figure 2-7 gives maximum signal pick-up.

D. NBS-A TO UT₂ TRANSLATOR

Many prefer to maintain their local standard referenced to UT₂ rather than to NBS-A. (The NBS-A time scale is kept by a clock based on the USFS, see

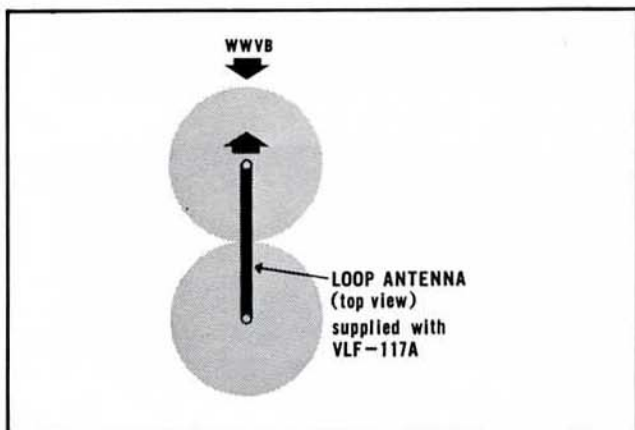

Figure 2-7. Orientation of VLF-117 Antenna for maximum signal pick-up

Appendix I.) Installation of a Translator Kit (HP Model 00117-91027) adapts the VLF-117A Comparator for this service. Figure 2-6 shows the connection of the translator into the basic system.

The translator derives the equivalent of a UT₂ referenced frequency from the received WWVB signal by continuously retarding its phase. The basic unit is a motor-driven synchronous resolver. Instabilities in the local power line frequency can affect short-term performance, but typical deviations in power line frequency (0.1%) have been found to cause errors of only about 1.5×10^{-11} . (Most power companies average much less than 0.1% deviation over any extended period.)

The offset of atomic time needed to yield UT₂ as announced by the Bureau International de l'Heure (see Appendix II) may change from year to year. Gear sets with different ratios can equip the NBS-A to UT₂ translators for other offsets.

A synchronous resolver operated by a frequency derived from a quartz crystal oscillator or other standard rather than from the ac line avoids any errors arising from line frequency changes. HP Translator K10-117A is such a device. It can be applied to the VLF 117A or to any other unit where a small and constant frequency offset is desired. The K10-117A can change either time scale to the other, that is, atomic time to UT₂ or vice-versa. The user's standard frequency (100 kHz) is divided down to 50 Hz to drive a motor which drives the synchronous resolver. Output is selectable in increments of 50 parts in 10^{10} (other increments can be provided by a simple change of a gear rack).

E. VLF COMPARISON SYSTEM

Figure 2-8 shows the basic system to compare a house frequency standard to the USFS via reception of the WWVB 60 kHz signal. The system is simple and straightforward.

A 20 kHz version of the 117A is available with the special designation H20-117A. While it can be useful to receive the 20 kHz broadcast of WWVL, for simultaneous monitoring with WWVB for additional comparison accuracy, it should be noted (see Appendix III) that WWVL is presently an experimental station. Transmissions may not always be in a format suitable for frequency comparisons.

F. RECORDER STRIP CHARTS

The 117A VLF Phase Comparator plots the phase difference of a locally generated signal vs. that of the received carrier by means of a self-contained strip chart recorder. Full-scale chart width can be set for either a $50 \mu\text{s}$ or $16 \frac{2}{3} \mu\text{s}$ phase difference. The recorder, of the sampling type, makes a dot on pressure-sensitive chart paper once every 60 sec. When standards of high precision are being calibrated and propagation conditions are stable, the trace resembles a continuous line.

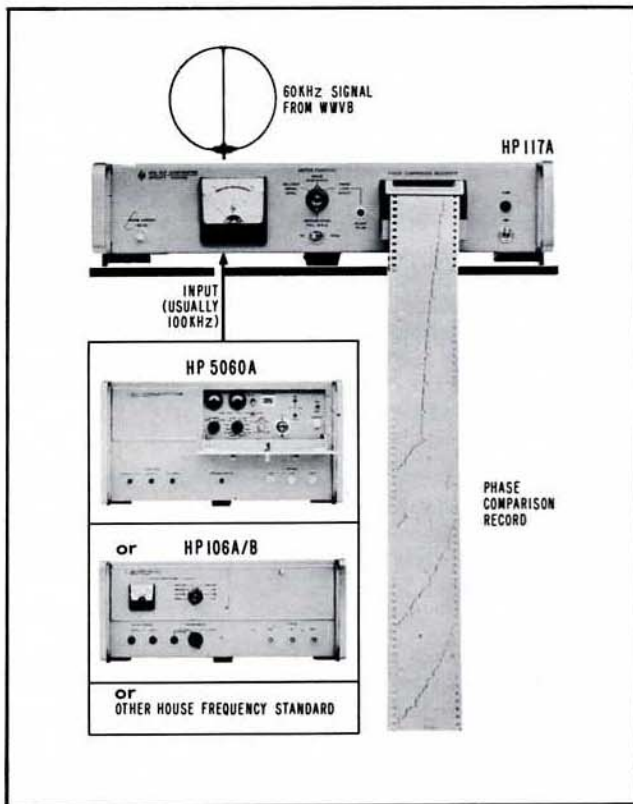

Figure 2-8. VLF Phase Comparison System

signal is equivalent to the rate of change in the phase difference measured over a time interval. The VLF Comparator plots this phase difference as a function of time with, under laboratory conditions, a resolution better than $1 \mu\text{s}$ of phase difference.

G. USE OF TRANSPARENT TEMPLATE.

The slope of the trace plotted by the 117A Comparator's strip chart recorder is, at a given instant, frequency offset between the local standard and the received signal $d\phi/dt$. So that this slope may be read at a glance, a set of transparent templates relating slope to frequency offset is provided with the 117A. One template is for use when the full chart width is $16\text{-}2/3 \mu\text{s}$ and the other for a full chart width of $50 \mu\text{s}$.

In use, the template is overlaid on the trace, the matching slope is selected, and the frequency offset (together with its sign) is then read from the template. The template is oriented so that it is aligned with the chart (with the long lines on the template parallel to the chart edges) and is moved back and forth along the chart until one of the template lines is found to have the same slope as the chart trace. The offset is then read directly from the template.

To establish the drift rate of a local oscillator, two determinations of the offset at separate times are required. The derivative of the slope of the recorded trace (rate of change of slope) is frequency drift rate or aging rate. Under favorable conditions of stable propagation, this drift can be attributed to the local standard.

Figure 2-9 shows a template superimposed upon a typical recorder chart at two separate chart times so that a drift determination can be made. At around

It is possible to make frequency comparisons by measuring changes in phase, over a period of time, between a locally generated signal (from a quartz crystal oscillator, counter time base, etc.) and the received carrier. The fractional frequency offset of the local signal with respect to the received

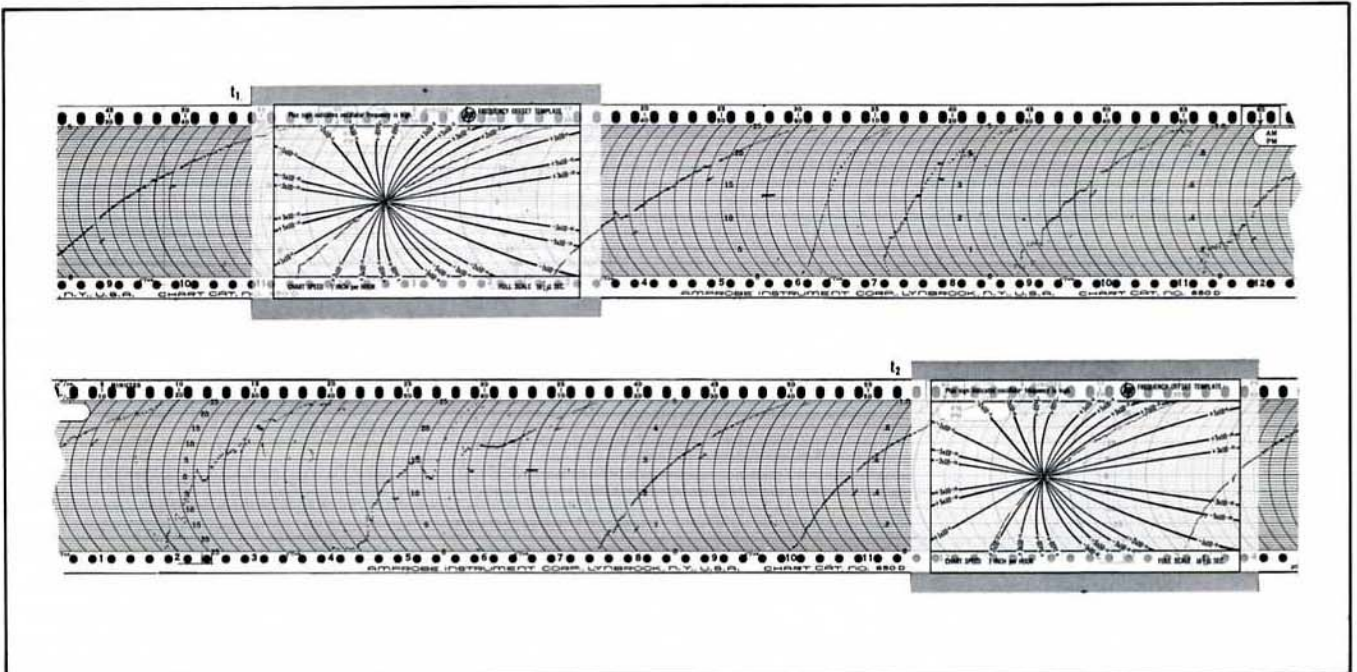

Figure 2-9. Use of template to interpret 117A recording

1:00 P. M. (point t_1), offset is read to be about $+1.5 \times 10^{-9}$. The following day, again about 1:00 P. M. (point t_2), offset is read to be about $+1.9 \times 10^{-9}$. Therefore, drift is

$$\begin{aligned} &+1.9 \times 10^{-9} \text{ (at } t_2) \\ (-) &+1.5 \times 10^{-9} \text{ (at } t_1) \\ \hline &+0.4 \times 10^{-9} \text{ (drift for 24 hours)} \end{aligned}$$

or, drift is +4 parts in 10^{10} per day.

It is possible, of course, to interpret the chart trace without use of the template. In fact, when the local oscillator is in agreement with the received signal to better than a part in 10^9 , it is more convenient to select two points on the trace some distance apart in chart time and to read off the change (at the full chart width of $16 \frac{2}{3} \mu\text{s}$, each minor division of the chart is $1/3 \mu\text{s}$). If N is the difference in μs of two readings three hours apart, then N can be said to be approximately the frequency offset of the local oscillator in parts in 10^{10} , at about the midpoint of the three-hour span. This is apparent from the following:

$$\frac{N \text{ microseconds}}{3 \text{ hours}} = \frac{N}{3(3600)10^6} \cong \frac{N}{10^{10}}$$

The fractional time error corresponds to the fractional frequency error:

$$\frac{\Delta t}{T} = -\frac{\Delta f}{F}$$

H. INTERPRETATION OF COMPARISON RECORDS

A number of examples of phase comparison records made with the VLF Comparator (Model 117A) are reproduced in Figures 2-10 and 2-11, together with short discussions of particular points brought out by

each record. Such records enable the user to evaluate his local standard over a short term or a long term, in a manner that makes the local standard traceable to the USFS.

A phase comparison recording, made on September 19, 1964, of WWVB against the Hewlett-Packard cesium standard at Palo Alto, California, is shown in Figure 2-10 (a). This recording agrees closely with the classic theory of an ideal propagation path.

Since the Hewlett-Packard cesium standard is in very close agreement with the U.S.F.S., which itself is derived from a cesium-controlled oscillator, all deviation from an arbitrary phase difference trace is due to variations in the propagation time of the 60 kHz WWVB signal. Although these effects have been exhaustively described over the past decade, it will perhaps be of interest to point out some of the characteristics of the VLF system. Note that the trace begins on the left at 5:30 a.m. at one inch per hour and the ordinate is time (phase) $16 \frac{2}{3} \mu\text{s}$ full scale. The trace is noisy and not well defined when the transmission is in darkness and useful only to show that unstable reception does occur. At sunrise, when the transmission path moves into sunlight, propagation time is decreased about $25 \mu\text{s}$ (propagation path is 900 miles), due to the lowering of an ionized layer in the ionosphere, together with an appreciable improvement in the quality of the trace. The signal is most stable and useful during the time when the entire propagation path is in sunlight. As the transmission path moves out of sunlight, beginning about 6:00 p.m., propagation time increases and the phase recording again shows noise and reduced definition.

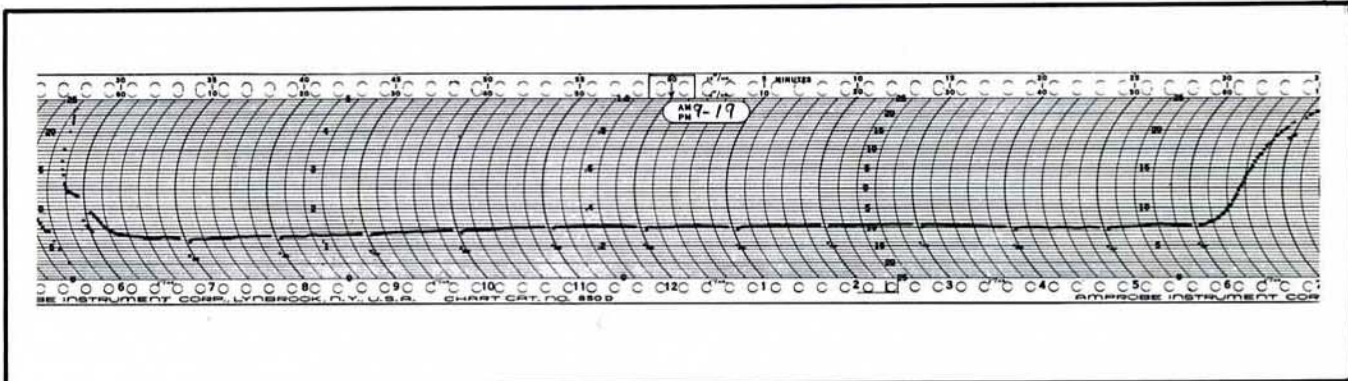

Figure 2-10 (a). Phase Comparison Plot for an Atomic Standard

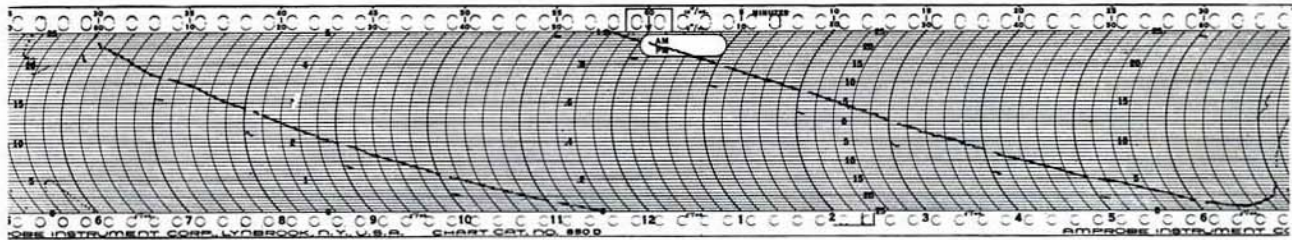

Figure 2-10 (b). Crystal Oscillator Stability Check

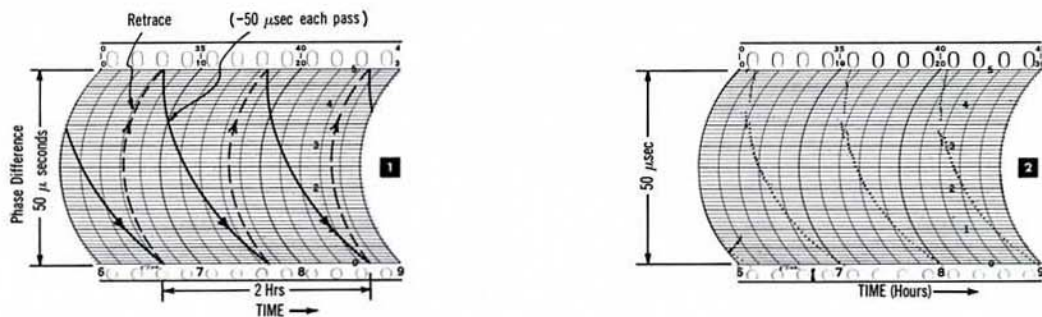

Figure 2-10 (c). Parts 1 and 2. Comparison Plots, UT₂ Local Standard without use of Translator

Figure 2-10 (b) is a portion of a 24-hour phase comparison recording made on the 117A, of the 5245L Electronic Counter 1 MHz time base crystal oscillator against the 60 kHz WWVB standard broadcast. This record was made on September 19, 1964. As shown here, the effect of the diurnal shift on the 60 kHz propagation path can be seen around 6:00 a. m. and 6:00 p. m. The crystal time base, during a 6-hour sunlight period, was checked and found to be aging positively at a rate of approximately 4×10^{-10} per 24 hours. (This was easily computed using the frequency offset templates provided with each instrument.) At 8:15 a. m. the slope of the frequency offset plot was -7.5×10^{-10} and at 3:00 p. m. was -6.5×10^{-10} . This shows a positive drift rate of approximately 1×10^{-10} per 6 hours or +4 parts in 10^{10} per 24 hours. A 24-hour check would increase definition and reduce diurnal effects.

The phase shifts on both Figure 2-10 (a) and (b), occurring shortly after the hour, are identification transmissions by WWVB (a 45-degree phase shift in the 60-kHz signal).

Figure 2-10 (c), 1 and 2, are comparison plots of a UT₂ local standard without the use of a translator.

Part 1. Idealized recorder trace shows accumulation of $-100 \mu\text{s}$ phase change ($-50 \mu\text{s}$ per pass) in 2 hours. Frequency offset of local standard frequency with respect to WWVB carrier therefore is $-100 \mu\text{s}/2 \times 60 \times 60 \times 10^6 \mu\text{s} = -140 \times 10^{-10}$, interpreted as $+10 \times 10^{-10}$ offset with respect to UT₂.

When a UT₂-referenced frequency standard is compared with WWVB by a VLF Phase Comparator that does not have a Translator, the phase record is accurately evaluated by determining the phase change accumulated over a definite period of time. The offset is readily computed as the ratio of phase change, measured in microseconds, to elapsed time (Part 1). This method, applicable to any offset, is valid since the fractional time error is the same as fractional frequency error ($\Delta t/T = -\Delta f/F$).

Part 2. Actual record made by HP Model 117A VLF Phase Comparator of locally-generated UT₂-referenced frequency against WWVB. Gaps in each pass are caused by once-an-hour 45° (2.083 μs) phase shifts introduced into WWVB carrier for identification purposes. Identifying phase shifts, which last five minutes, show up as 2- μs displacement of 5-dot line segment.

Ionosphere phase anomalies are sufficiently unlike the nature of a quartz (or atomic) standard's aging characteristic as to be easily distinguishable. Occasionally, daytime ionosphere activity does occur (mostly in the winter months) and should be recognized for proper evaluation of the data records.

Achieving maximum usable comparison precision of the WWVB signal can be accomplished by giving greater weight to phase records made during days having the more constant signal level. If daylight fading should occur, it is a certain indication that ionosphere disturbances are taking place and these are likely to be

a Phase comparison plot, HP house standard vs WWVB, $16\frac{2}{3}$ μ s full scale, Jan 21, 1965

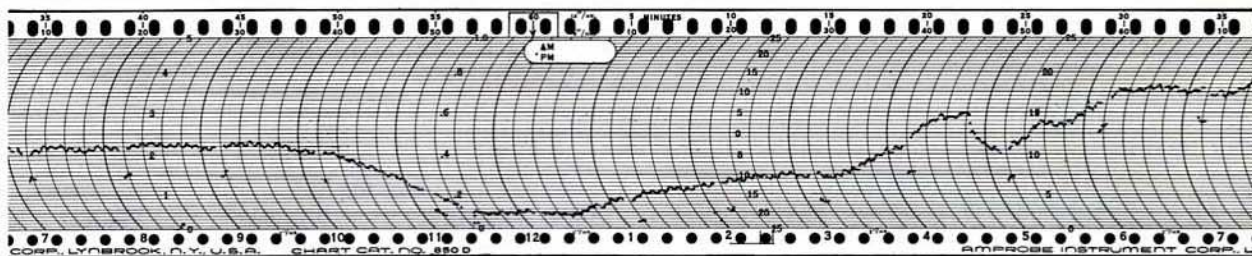

b Phase comparison plot, HP house standard vs WWVB, $16\frac{2}{3}$ μ s full scale, Mar 4, 1965

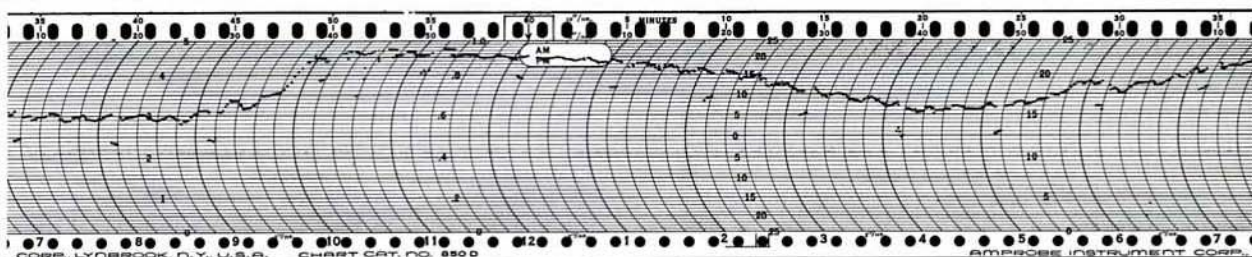

Figure 2-11. Phase comparison recordings showing effects of propagation anomalies

accompanied by apparent received phase instabilities. The maximum error attributable to ionosphere disturbances experienced at Palo Alto on WWVB was about 1×10^{-9} during November 1963. Another helpful method of determining accuracy depends on a fairly good knowledge of the behavior of one's own local standard. Once the aging rate has been determined, it can be removed from the phase records with reasonable accuracy.

The two phase comparison plots shown in Figure 2-11 (a) and (b) are examples of phase anomalies that are attributed to ionospheric disturbances. Both traces are plots of the received 60 kHz WWVB signal against the Hewlett-Packard house standard. During the time covered by these phase records, the HP standard was known to have an aging characteristic of 2 parts in 10^{11} and a relative frequency offset of about a part in 10^{10} .

In Figure 2-11 (a) the phase stability of the 60 kHz signal was such that, for high accuracy work, the phase record was most useful only between the hours of 7:00 A.M. and 10:00 A.M. During these three hours in the morning the average slope of the trace was approximately $+1 \mu$ s for 3 hours corresponding to a frequency offset of one part in 10^{10} . This information has limited usefulness in itself. The important thing to keep in mind is that for high accuracy work, phase records must be made and compared on a day to day basis for a period of time sufficient to average out all phase anomalies.

In Figure 2-11(b) the phase instabilities due to transmission path anomalies are such that the entire phase recording is limited in usefulness. However, the received stability in both cases, 2-11 (a) and (b), is

about 5 parts in 10^{10} for the period between 7:00 A.M. and 6:00 P.M. On days when propagation conditions result in a less usable phase record, experience has shown that useful information can frequently be obtained shortly after the morning diurnal shift - about 8:00 A.M. (in Palo Alto, California).

Unless the trace positively defines a readable slope, it is better to measure the beat frequency by counting cycles of the front panel meter with the switch set to Phase Comparison. Generally speaking if the stability of the standard to be calibrated is at least 1×10^{-7} /day, there is little reason to use WWVB as a reference unless there is no other simpler method available for low accuracy work. The following dot spacing is included here to show what kind of results to expect with standards of various offset frequencies:

Offset	Dot Spacing
1×10^{-6}	60 μ s
8.33×10^{-7}	50 μ s
1×10^{-7}	6 μ s
1×10^{-8}	0.6 μ s
1×10^{-9}	0.06 μ s

If one attempts to make coherent records over many days time, using the 50 μ s scale calibration, it is likely that the phenomenon of an integral number of advancing or retarding full 360 degree phase shifts may be recorded which will move the recorder trace in increments of $16\frac{2}{3}$ μ s and thereby appear to lose coherence. The obvious way to avoid this is to use the $16\frac{2}{3}$ μ s calibration when making measurements for periods of time longer than one working

day. The fact that such phase shifts take place certainly creates a problem for any kind of timing or accumulating system which attempts to utilize the VLF radio wave itself instead of a carefully maintained local standard. Many observers have noted full cycle phase rotations during diurnal phase shifts at many frequencies.

When an interruption occurs to the incoming signal or to the local standard, a phase jump may result in the VLF-117A trace. The jump depends upon whether the full-scale calibration is set for $16\frac{2}{3}\ \mu\text{s}$ or for $50\ \mu\text{s}$. The list to follow predicts this phase jump:

HP 117A VLF COMPARATOR
Incremental Phase Jumps

TYPE OF INTERRUPTION	POSSIBLE PHASE JUMP	
	50 μs FULL SCALE	16-2/3 μs FULL SCALE
WWVB Signal Outage	1/3 full scale	No Change
Local Standard Outage	1/5 full scale	1/5 full scale
VLF-117A Switched (16 2/3 μs to 50 μs or 50 μs to 16-2/3 μs)	1/5 full scale	1/5 full scale
AC Power Outage	1/15 full scale	1/5 full scale

I. OTHER LF/VLF COMPARISON SYSTEMS.

While no other LF or VLF comparison method offers the convenience and simplicity afforded by use of the HP 117A VLF Comparator just described, there are a number of equipment arrangements which can be used.

Two methods will be discussed here. One involves the use of an electronic counter in its time interval mode for the comparison and the other uses an oscilloscope display.

The system that employs a simple LF/VLF receiver, a time interval counter and other equipment as shown in Figure 2-12(a), could serve to determine the drift of a local standard such as a quartz crystal oscillator.

*At this writing, U. S. Navy station NBA is off the air for modifications.

For example, suppose the 20 kHz signal from NBS station WWVL is to be the reference. The quartz oscillator output drives the Model 115BR/CR Frequency Divider and Clock. The Clock's 1 kHz output is used to start the interval count and the received 20 kHz carrier is used to stop it. The Model 5233L counter's trigger level and slope controls permit the selection of precisely repeatable points on the start and stop waveforms. The Model 581A Digital-Analog Converter and the Model 680 Recorder make, from the time interval counter's measurements, a continuous record from which the relative time drift of the local oscillator can easily be determined.

A short calculation indicates that this method makes possible a comparison accuracy of a part in 10^9 or better in an hour. Since there are approximately 4×10^9 microseconds in one hour, a frequency difference of a part in 10^9 between the received signal and that from the local standard would result in a time drift of about 4 microseconds over a one hour measurement. This value is found to be well within the resolution of the equipment. The Model 115BR/CR Clock's output has a jitter of less than a microsecond, and time interval measurements can be made with a Model 5233L Counter to within a few microseconds.

As a second example, suppose an interrupted continuous wave (ICW) transmission such as that from U.S. Navy Station NBA* is to be the reference. The NBA transmitter is keyed once per second for 0.3 second. Frequency comparisons can be made only when the pulse is on, so the comparison scheme differs somewhat from that of the preceding example. The equipment setup is the same, but a 1 pps tick from the Model 115BR/CR, rather than the 1 kHz output, is the start signal to the counter.

So that comparison can be made to a given point on the VLF carrier, the pulse from the clock is positioned by adjustment of the Time Reference Control on the clock panel to occur in the middle or late portion of the received VLF pulse (in this way, any variations during the early part of the VLF carrier pulse will not affect the character of the carrier cycle used to stop the time interval counter). The clock pulse is then used to start a time interval measurement on the time interval counter. The measurement will be stopped by the point on the next cycle of the VLF carrier which corresponds to the trigger level and slope setting of the stop channel controls on the time interval counter.

Because the transmission, in this case, is interrupted at 1-second intervals, time interval readings can only be made at a once-per-second rate. The reading rate when comparison is made to a cw station such as WWVL is limited only by the sample rate and speed of the measurement and recording system.

Calculation of the frequency error of the local standard can be made as described in Section IV-5 and is based upon the time drift of the average time interval readings.

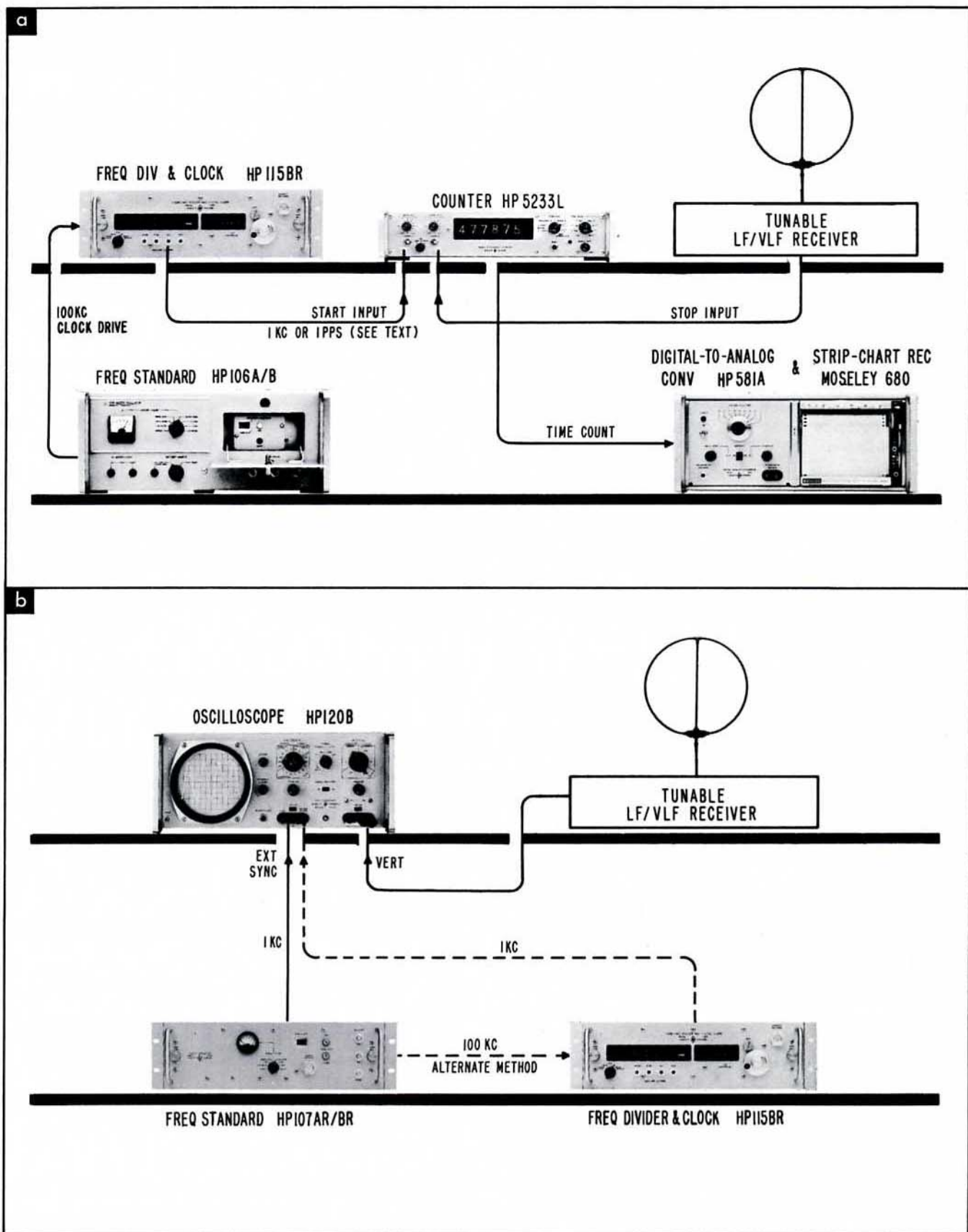

Figure 2-12. LF/VLF Comparison Systems

A comparison method that employs an oscilloscope to make possible a visual comparison of a local oscillator against LF/VLF signals can be set up as shown in Figure 2-12 (b).

The signal is received and amplified and is displayed on the oscilloscope (vertical axis), which is synchronized externally by a signal from the local standard being compared. An alternate system applies the local standard's output to a Model 115BR/CR which serves as a divider. The LF/VLF signal must be a whole multiple of the signal used to trigger the oscilloscope sweep.

Comparison measurements are made by positioning the zero crossing of the waveform to some reference point on the oscilloscope and observing the amount and direction of drift over a period of time. A drift toward the right of the screen would indicate that the frequency of the local standard is high, whereas a drift to the left indicates a frequency that is too low. Average frequency error may be calculated from the following relationship:

$$\left| \frac{\Delta f}{f} \right| = \left| \frac{\Delta t}{T} \right|$$

where Δf = average frequency error

Δt = amount of drift during period T

T = comparison period

Care must be taken when observing interrupted cw broadcasts (e.g., NBA) that noise during the "off" time of the signal (caused primarily by circuit ringing in narrow band, high gain receivers) is distinguished from the "on" portion of the signal. This noise as present in the receiver output is sinusoidal, approximately the same frequency as the carrier signal, and can be of sufficient amplitude to cause possible confusion.

Comparison accuracy of this technique is determined by oscilloscope trigger stability, sweep calibration accuracy, and the user's ability to integrate and resolve Δt . It is not recommended that frequency standards with accuracy requirements better than several parts in 10^9 be calibrated by this method.

7. TIME RECORD WITH THE VLF COMPARATOR

WWVB broadcasts time information presented by a power level shift indication based on a binary coded decimal notation (see Appendix III). The addition of a strip chart recorder to the HP 117A makes it possible to obtain a record that tells minute-by-minute the day of the year, the hour, the minute, and the correction in milliseconds to arrive at UT₂.

Figure 2-13, Part a, shows the connection of the HP 117A to a Model 680 Recorder, and Part b shows the

trace representing a portion of a minute. Figure III-4, Appendix III displays the entire minute pattern for a typical minute. To read the example trace, refer to Figure III-4 and compare Figure 2-13 against it.

To read an actual strip chart, it is helpful first to bracket a minute by location of two consecutive double pulse markers. Then the 10 sec markers and the uncoded markers should be located. Once each information area is separately bracketed, its binary-coded-decimal information can be read easily.

Figure 2-13 (c) shows use of a paper template prepared from the information of Figure III-4, Appendix III, to suit the particular chart speed (12 in/min). Placed over the trace, such a template makes it easy to read the binary code.

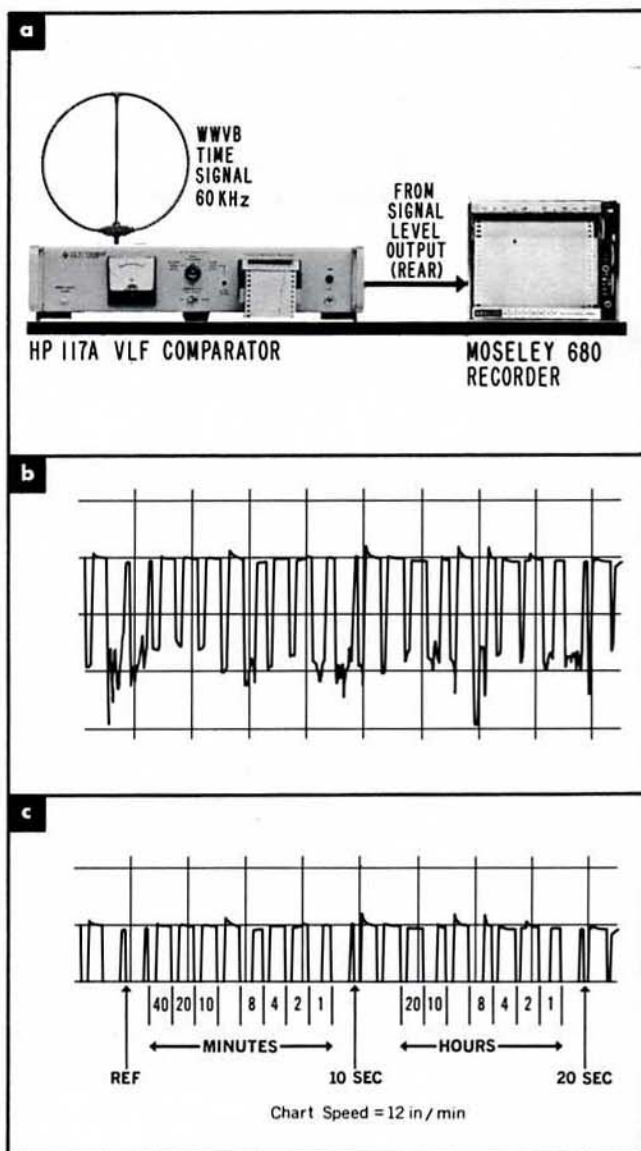

Figure 2-13. Equipment to produce a time record (a), a trace (less than a minute) produced with this equipment (b), and the same trace with a template superimposed to aid in its interpretation (c).

8. POWER SUPPLY CONSIDERATIONS

Continuous operation is important to a frequency standard system and is vital to a time standard. Hewlett-Packard power supplies designed for use with standards systems provide for continued operation in the event of ac line failure, or while the system is being transported. Nickel-cadmium batteries supply the standby power.

The HP Models 724BR and 725AR, and the 5085A, are designed to operate with the standby batteries floating across the regulated output to assume the load automatically in case of ac line failure. The frequency or time standard system is not affected by transfer of load from any external supply to standby or back again, since no switching is used. When ac power comes back on, the supply automatically re-assumes the load and recharges the batteries. Front panel lights report operating conditions, indicating whether operating power is ac line or battery. Provision is made for the connection of an independent external alarm system.

9. IN-PLANT DISTRIBUTION OF STANDARD FREQUENCIES

At the Hewlett-Packard main plant, a distribution system originating with the working standard carries standard frequencies to terminals at individual workbenches remote from the standards laboratory. Signals are carried via shielded cables. A distribution amplifier system, designed specifically for the purpose, isolates and protects the working standard from noise and spurious signals which might otherwise be fed back. Depending on the signal quality needed, some users have additional distribution amplifiers at their stations.

While a distribution system of shielded cables can successfully deliver average frequency (that is, the correct number of cycles for some long interval of time), it is quite difficult to maintain the delivered signal at a high level of spectral purity. Amplifiers inevitably introduce noise, and sometimes distortion. Electrostatic and electromagnetic fields and ground currents can introduce unbalance currents which appear at the far end of the system as phase changes in the signal. Even if use of carefully shielded and balanced lines has kept electric interference to a minimum, phase changes can arise from temperature changes. All practical lines have attenuation which changes with temperature.

At Hewlett-Packard, it is the practice to use separate frequency standards in work areas where signals of high spectral purity are required. These standards are referred to the house standard by signals carried over the distribution system. Such a comparison makes possible the removal of any short-term variations arising in the distribution system. Where signal purity requirements are moderate, crystal filters at the system output can reduce noise to a reasonable level.

Wire telephone lines and cables are generally not suitable to distribute standard frequencies because of the limitations already discussed. Clocks can be operated from a signal carried over wire lines. The clock mechanism serves as an integrator to remove the effects of noise. Carrier systems are not suitable for frequency standard work since most use a suppressed carrier transmission. When the receiving terminal does not reinsert a carrier of the exact frequency used by the transmitter, errors are caused in all frequencies transmitted through the system.

10. PRECISION VARIABLE FREQUENCY SOURCE

The HP Model 5100A/5110A Frequency Synthesizer* makes it possible to translate the stability of a precision frequency standard to other frequencies within a specific band of interest. Different stable frequencies may be selected very rapidly if desired.

In areas such as microwave spectroscopy, space doppler, and production testing of frequency sensitive devices, there is application for an instrument capable of retaining the basic stability and spectral purity of the driving standard, yet offering 5×10^9 frequencies selected in steps as fine as 0.01 Hz. Frequency range of the 5100A is 0.01 cps to 50 MHz.

Figure 2-14 shows the 5100A/5110A. The 5110A is the synthesizer driver. The selected output frequency is derived from a single precision frequency source by means of direct synthesis.



Figure 2-14. HP Model 5100A/5110A Frequency Synthesizer

*V. E. Van Duzer, "A 0-50 Mc Frequency Synthesizer with Excellent Stability, Fast Switching, and Fine Resolution", *HP Journal* 15, 9 (May 1964).

Direct synthesis employs only mixing, multiplying, and dividing, thus avoiding problems associated with the indirect synthesis method commonly used. One primary advantage of direct synthesis is rapid switching. In indirect synthesis, where a variable frequency oscillator is referenced and phase locked to a fixed crystal oscillator, phase-locked loops must settle to a final value upon the selection of a new output frequency. The 5100A/5110A's switching time is less than 20 μ s.

With the 5100A/5110A, the user can select from the wide range of frequencies made available by this instrument, each frequency retaining the purity and stability of his local standard (input may be 5 MHz

or 1 MHz or the unit's own precision oscillator may be used).

Two additional synthesizers, HP Models 5102A and 5103A, are offered to meet requirements which are satisfied by a range of frequencies less than the wide 0.01 Hz to 50 MHz range of the 5100A/5110A. The HP Model 5102A provides any output frequency from 0.01 Hz to 1 MHz in two ranges: (1) 0.1 Hz to 1 MHz in steps as small as 0.1 Hz and (2) from 0.01 Hz to 100 kHz in steps as small as 0.01 Hz. The 5103A provides any output from 0.1 Hz to 10 MHz in two ranges: (1) 1 Hz to 10 MHz in steps as small as 1 Hz and (2) 0.1 Hz to 1 MHz in steps as small as 0.1 Hz.

SECTION III

**METHODS FOR PRECISE
FREQUENCY STANDARD
INTERCOMPARISONS**

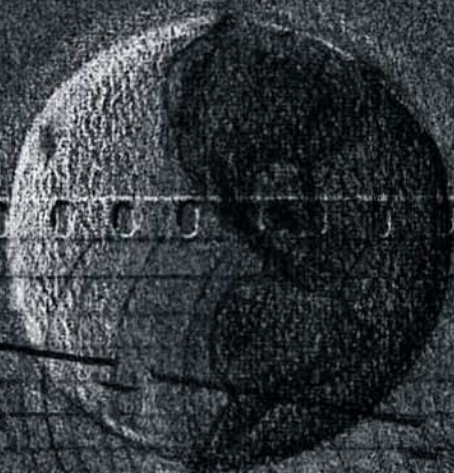

SECTION III

METHODS FOR PRECISE FREQUENCY STANDARD INTERCOMPARISONS

1. GENERAL

In Section II various methods were discussed for calibrating a "house" or "local" standard against a frequency standard broadcast. Two types of data could be determined from these comparisons; the frequency offset or frequency difference and the aging or frequency drift characteristics of the local standard. It is usually impractical to maintain a large number of frequency standards (crystal oscillators in synthesizers, counter time bases, etc.) directly to a standard broadcast. It is often desirable to maintain a house standard to the USFS and to use it as a transfer standard for local frequency offset and drift comparison work. In addition, it is generally impossible to use a received frequency standard broadcast signal for short-term stability (fractional frequency deviations or fractional phase deviations) comparison work. Here the availability of a stable, spectrally clean local standard is a necessity.

To be useful, methods for comparing frequency standard oscillators against a precision house frequency standard must be capable of resolving extremely small differences. This section describes five such useful methods that have varying complexity and resolution. Two methods involve the use of an oscilloscope for interpretation and three use the period measuring capability of an electronic counter or various other support equipment for the comparisons.

In all of the methods discussed here, the local house standard or reference standard is assumed ideal for purposes of comparison.

2. OSCILLOSCOPE LISSAJOUS PATTERNS

A well known method of comparing two frequencies is to observe the pattern displayed on an oscilloscope when one frequency is applied to its horizontal input and the other to its vertical input. If the ratio of the frequencies is an integer or the ratio of two integers, the resulting pattern called a Lissajous figure can be interpreted to determine this frequency ratio. If a rectangle is imagined to bound the pattern, the number of points where the loops are tangent on one vertical and one adjacent horizontal side directly indicates the ratio of the two frequencies. A Lissajous figure showing three points tangent to the horizontal and one point tangent to the vertical would indicate a 3:1 frequency ratio between the applied frequencies, while the figure shown in Figure 3-1 has a 5:2 ratio.

Lissajous figures take on a large variety of shapes as initial phase relationships are altered, and interpretation of the patterns is complicated by the retrace of the returning spot over the same path it took when moving forward. It is possible to refine the method by such means as use of phase shifters to make ellip-

tical displays. Reference to a comprehensive presentation on Lissajous patterns is advisable.*

A 1:1 relationship of comparison frequencies produces an ellipse with opening and inclination dependent upon amplitude and phase relationships of the applied signals. Phase shift determinations are often made from such an ellipse.** Slight frequency differences cause the ellipse to pass repeatedly through all the orientations from 0° to 360°. It is possible to time the completion of a 360° sequence and to find frequency difference, which is the reciprocal of this time (in seconds). To match the frequency of an oscillator closely to that of a house frequency standard, the oscillator is adjusted until the ellipse is stationary.

The practical limit for use of this technique for frequency offset adjustments and comparisons is about one part in 10⁹. As an example, if the time required for a Lissajous figure to "rotate" through 360° is 100 seconds and the two signals used as inputs are 1 MHz the offset would be:

$$\Delta f = f_{\text{off}} = \frac{1}{T_{\text{off}}} = \frac{1}{100} = 1 \times 10^{-2} \text{ hertz,}$$

or, related to the 1 MHz signal,

$$\frac{\Delta f}{f} = \frac{1 \times 10^{-2}}{10^6} = 1 \times 10^{-8} \text{ (offset)}$$

This technique is not practical for quantitative fractional frequency deviation measurements.

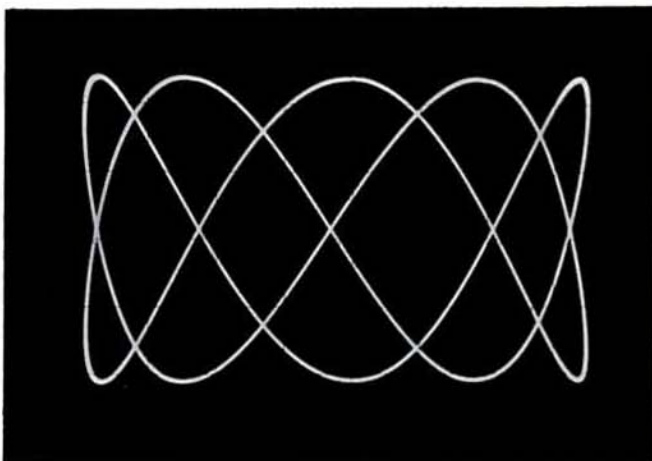

Figure 3-1. Lissajous pattern (frequency ratio 5:2).

*J. Czech, "The Cathode Ray Oscilloscope" Clever-Hume Press, Ltd., London, 1957. See also: Rider and Usland, "Encyclopedia on Cathode Ray Oscilloscopes", Rider, Inc., New York, 1959.

**HP Application Note 29, "A Convenient Method for Measuring Phase Shift".

3. OSCILLOSCOPE PATTERN DRIFT

An oscillator can be compared against a house frequency standard by externally triggering the oscilloscope from the standard while a pattern of several cycles of the oscillator is displayed. The ratio of drift of the oscilloscope pattern is related to the frequency error of the oscillator under test. For example, suppose an HP 175A Oscilloscope is being used to check the time base oscillator frequency of an HP 5245L Electronic Counter against a house standard such as the HP 107AR/BR Quartz Oscillator. The equipment arrangement is shown in Figure 3-2.

If the oscilloscope pattern apparently moves to the right, the counter's time base oscillator frequency is low compared to that of the standard; if the pattern moves to the left, the counter frequency is high.

Rate of movement can be interpreted in terms of frequency error in this way. With a 1 MHz signal from the standard used to trigger the display of a 1 MHz signal from the counter's internal oscillator, the time required for the pattern to apparently drift the width of one cycle of the display is noted. Suppose that the pattern drifts left the width of one cycle in a time of 10 sec; this is equivalent to a frequency difference of 0.1 cycle per second. Frequency error, then, is 1 part in 10^7 (high):

$$\frac{\Delta f}{f} = \frac{0.1}{10^6} = 1 \times 10^{-7}$$

If it takes 100 sec for the pattern to drift the width of one cycle, the error is 1 part in 10^8 .

$$\frac{\Delta f}{f} = \frac{0.01}{10^6} = 1 \times 10^{-8}$$

If two 100 kHz signals are being compared and movement the width of one cycle takes 1 sec, the frequency error is 1 part in 10^5 ,

$$\frac{\Delta f}{f} = \frac{1}{100 \times 10^3} = 1 \times 10^{-5}$$

With the oscilloscope pattern drift method, as in the Lissajous method, the largest error will come from the method used for timing. The best technique for both of these frequency difference measurements is to adjust the oscillator being tested until there is little or no apparent movement on the oscilloscope. This will allow a longer observation time for the drift of one cycle and will reduce the visual timing error.

4. DIRECT FREQUENCY COMPARISON WITH A COUNTER

A frequency counter can serve to compare two oscillators against each other. The reference oscillator, substituted for the counter's internal time base, establishes the interval. Then cycles from the second oscillator are counted during that interval. Suppose that two 1 MHz oscillators are being compared. The ± 1 count ambiguity limits precision to 1 part in 10^6 for a 1 sec interval. A 10 sec interval could increase precision to 1 part in 10^7 , but to intercompare two oscillators to a precision of parts in 10^{11} would require an interval an entire day in length if the only means to increase precision were to extend the interval.

The time needed per measurement can be reduced by multiplying the frequency of the oscillator being checked before it is counted. Suppose one signal is multiplied by 1000 to 1 GHz. Then using an electronic counter-heterodyne frequency converter plug-in combination (such as the HP 5245L counter and the

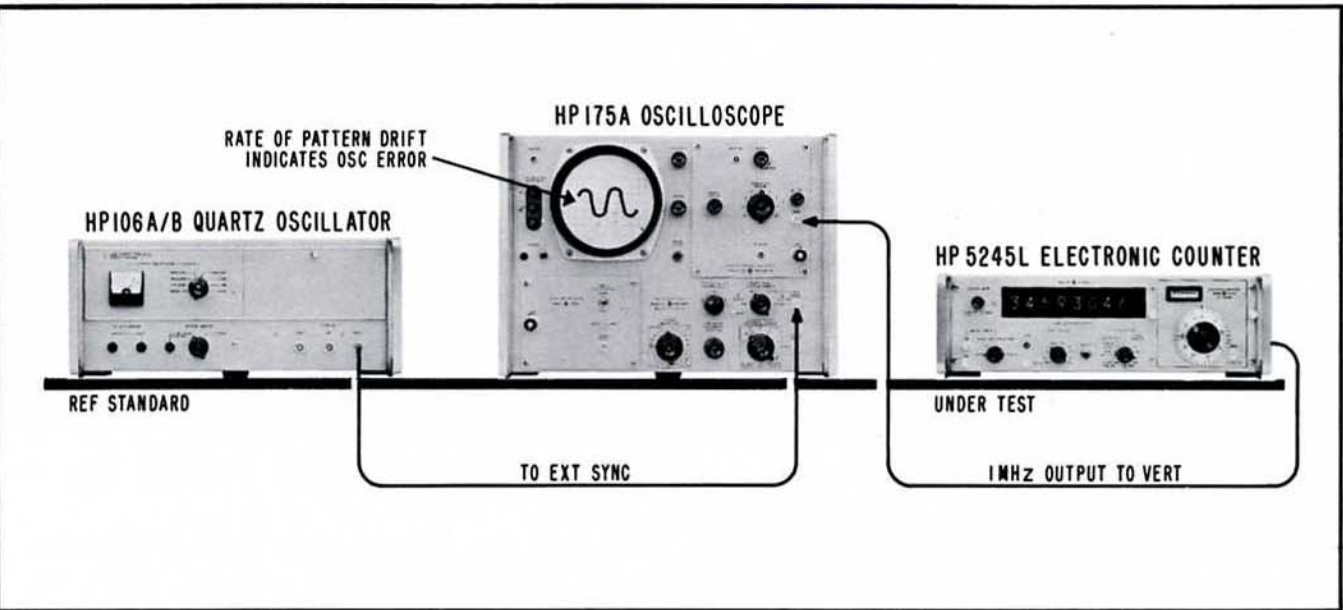

Figure 3-2. Equipment to check a counter's internal oscillator.

HP 5254A 300 MHz-3 GHz Frequency Converter) the 1 GHz frequency may be easily counted. A one-second counting interval will give a comparison of 1 part in 10^9 and a 100-second interval will give 1 part in 10^{11} .

If the multiplication factor is so large that transfer oscillator techniques must be used to count the frequency, the possible gain in precision is cancelled by the lack of coherence in the measurement. The overall limitation is the product of the measurement time and the maximum frequency measurable by either direct counting or heterodyne conversion.

This direct frequency comparison technique may be used to determine frequency offset, relative aging characteristics and fractional frequency deviations (if the measurement interval is kept below 10 seconds). The use of a printer such as the HP Model 562A Digital Recorder (and/or a digital-to-analog converter and strip chart recorder combination) facilitates the recording of data for the frequency comparison measurements.

5. DIRECT COUNTER READOUT OF FREQUENCY ERROR

Where a number of comparisons of precision oscillators expected to agree in frequency within parts in 10^6 (or better) are to be made against a house frequency standard, it is convenient to arrange equipment so that a counter's readout can be interpreted directly in terms

of frequency error to an accuracy of parts in 10^6 , in 10^7 , in 10^8 , etc. The equipment arrangement to accomplish this direct readout uses a precision oscillator which has been offset by an amount predetermined as described here. The offset frequency and the frequency from the oscillator under test are mixed and the period of their difference frequency is measured. Such a comparison constitutes a short-term stability measurement; the changes in period of the difference frequency indicate the instabilities of the test oscillator (reference frequency is assumed to be stable). The period displayed on the counter's readout can easily be interpreted (digit by digit from left to right) as frequency error (for example, parts in 10^6 , in 10^7 , etc.).

To illustrate the method, let us assume a quartz oscillator's 1 MHz output is to be compared against a reference oscillator. The system shown in Figure 3-3 is set up and is calibrated by the substitution of a known 1 MHz signal (from the house standard) for the oscillator under test. The 107BR is adjusted in frequency until the counter display is exactly 1,000,000.0 μ s. The 107BR is now at a frequency of approximately 1 MHz \pm 1 Hz. The known 1 MHz signal is now removed from the mixer input and the oscillator under test is applied in its place. The counter's visual display can now be read directly to parts in 10^X for each measurement cycle. If the BCD output is converted to analog form and plotted on a strip chart recorder, a plot of $\Delta f/f$ with respect to time is obtained.

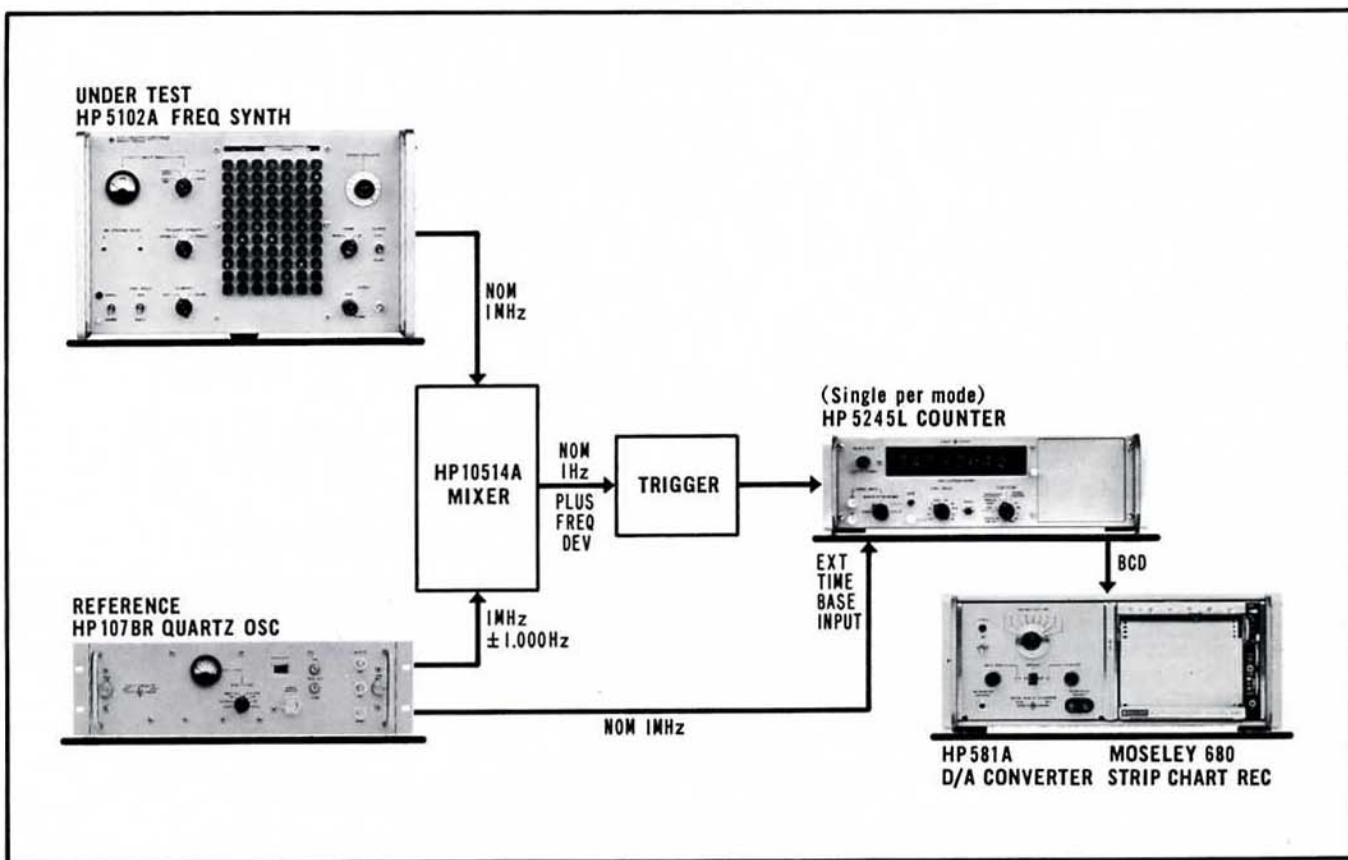

Figure 3-3. Block diagram for frequency comparison measurements.

As an example, to compute what fractional frequency deviation is indicated for the oscillator under test when the period displayed on the counter's readout is observed to change by one microsecond, the following approximate method can be used:

$$f = \frac{1}{\tau} = \tau^{-1}$$

Where:

f = frequency, Hz

τ = period, sec

Differentiating,

$$df = -\tau^{-2} d\tau = -\frac{d\tau}{\tau^2}$$

Dividing both sides by frequency:

$$\frac{df}{f} = \frac{-d\tau}{\tau^2 f}$$

We can write:

$$\frac{\Delta f}{f} = -\frac{\Delta \tau}{\tau^2 f}$$

With the following interpretation:

$\frac{\Delta f}{f}$ = Fractional frequency offset in the frequency being checked

$\Delta \tau$ = Change in the period displayed on the counter

τ = Period of input signal to the counter (difference frequency)

f = Frequency being checked

With the substitution of values:

$$\Delta \tau = 1 \mu\text{s} = 10^{-6} \text{ sec}$$

$$f = 1 \text{ MHz} = 10^6 \text{ Hz}$$

$$\tau = 1 \text{ sec}$$

$$\frac{\Delta f}{f} = -\frac{10^{-6}}{\tau^2 (10^6)} = -\frac{10^{-6}}{(1)^2 10^6} = -10^{-12}$$

Thus, when the period displayed on the counter is observed to change by $1 \mu\text{s}$, the fractional frequency deviation is indicated to be one part in 10^{12} . This $\Delta f/f$ is attributed to the test oscillator. The reference oscillator (and the system) are assumed to be ideal. Note that this development has neglected measurement system jitter and counter resolution. Period measurements are subject to possible errors even if the mixing frequency and the counted frequency are known exactly, for example, the ± 1 count error. The nominal resolution of 1 part in 10^{12} cannot be realized.

The period displayed on the counter's readout can be interpreted in this way. Suppose the counter is a HP-5245L set up to count a 10 MHz signal (Time Base set to $0.1 \mu\text{s}$) in the one-period average mode, and that the gate is controlled by the difference frequency, 1 Hz. The counter readout, with a $1 \mu\text{s}$ change inter-

preted to mean a part in 10^{12} fractional frequency deviation, will be as follows, with the digits to the left, in turn, representing the deviations shown:

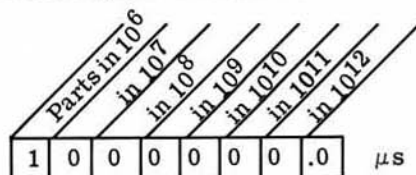

If desired, the Moseley 680 Strip Chart Recorder, and the 580A Digital-Analog Converter can be set to plot the analog of the three digits immediately to the left of the decimal point. Full-scale resolution would then be 1×10^{-9} . This plot will show short term or fractional frequency deviations and if continued for a long period of time (many hours to a day or more) the test oscillator's drift with respect to the reference oscillator can be determined.

By use of this same technique it may be desirable to compare two 5 MHz frequencies. Using the equations previously developed, the period (inverse of the offset frequency) that should be measured is easily determined.

$$\left| \frac{\Delta f}{f} \right| = \left| \frac{\Delta \tau}{\tau^2 f} \right|$$

Solving for τ :

$$\tau^2 = \frac{\Delta}{\frac{\Delta f}{f}(f)}, \quad \tau = \sqrt{\frac{\Delta \tau}{\frac{\Delta f}{f}(f)}}$$

If the desired measurement is 1 part in 10^{12} for a $1 \mu\text{sec}$ change in the period measurement display column, then:

$$\frac{\Delta f}{f} = 1 \times 10^{-12}$$

$$\Delta \tau = 10^{-6} \text{ sec}$$

$$f = 5 \times 10^6 \text{ Hz}$$

Substituting:

$$\tau = \sqrt{\frac{10^{-6}}{(10^{-12})(5 \times 10^6)}} = \sqrt{\frac{1}{5}} = 0.4472135 \text{ sec}$$

The offset frequency determined from the desired offset period measurement would be (approximately) 2.25 Hz in order to have a $1 \mu\text{sec}$ change equivalent to a $\Delta f/f$ of 1 part in 10^{12} .

6. PHASE NOISE MODULATION MEASUREMENTS

In the measurement and specification of the short-term stability of a signal or a particular signal source an extremely useful technique is the plot of phase noise

and spurious signals versus frequency-of-offset. * This form of short-term stability measurement will allow the evaluation and comparison of signals for a particular application. It is especially useful in areas where system band limiting is used since it presents a complete picture of random sideband noise. The information obtained by this technique makes it useful in connection with measuring short-term stability contributions of passive devices such as frequency dividers, multipliers, etc.

The amplitude modulation is assumed to be much smaller than the phase modulation for a high quality signal. If this is not the case, a similar limit plot would be of interest because of its direct effects and its easy conversion to phase modulation in the application of the signal. As a practical matter, the effects of environmental conditions on stability should perhaps be indicated. In this section only the measurement and analysis of phase modulation will be discussed.

In its simplest form, the effects of phase noise on a signal (carrier) may be represented by a vector diagram as shown in Figure 3-4. Since the noise contributions being observed here are truly random, they will appear as numerous symmetrical sidebands around the carrier signal (E_C). Looking at a single pair of sidebands e_{SL} (lower) and e_{SU} (upper) the peak deviation contributed by these can be shown to be $2e_S$. (Since they are symmetrical pairs, their absolute magnitude and instantaneous angular velocity, with respect to the carrier, is identical.)

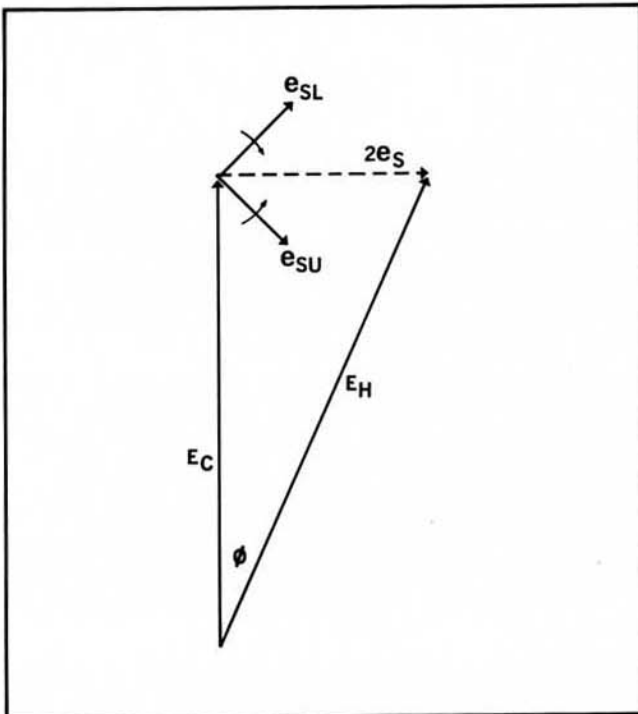

Figure 3-4. Vector representation of phase noise modulation

The resultant signal is E_H . For small values of ϕ :

$$E_H \cong E_C$$

and

$$\sin \phi \cong \phi \text{ (in radians)}$$

The phase noise contribution for these pairs is ϕ , or, in the general use, ϕ_N .

Therefore

$$\sin \phi = \phi = \frac{2e_S}{E_H} = \frac{2e_S}{E_C}, e_S = \frac{\phi E_C}{2}$$

The sideband distribution, then, consists of symmetrical pairs whose relative amplitude compared to the carrier is equal to 1/2 of the peak phase deviation of that component in radians.

In this measurement, synchronous signals are compared by means of a phase detector. The instrumentation setup shown in Figure 3-5 is an example of a typical system. The output of the phase detector, $e_N(t)$ is the instantaneous voltage analog of the phase noise contribution from the oscillator under test. For measurement purposes the reference oscillator, an HP 106B Quartz Oscillator, is assumed perfect.

For the phase detector to be held to a zero output, except for the phase noise contributions, the oscillator under test must be kept in quadrature with the reference oscillator. This is accomplished by using an HP413A DC Null Voltmeter as a direct coupled amplifier to sense a zero phase detector output and drive the test oscillator to phase quadrature.

The phase noise will now be represented by a voltage out of the phase detector, $e_N(t)$, that is related to the phase noise by some constant.

$$e_N(t) = A \cos \left[\frac{\pi}{2} + \phi_N(t) \right] = A \sin \phi_N(t)$$

for small values of ϕ ,

$$e_N(t) = A \phi_N(t).$$

This constant, A , can be determined by the use of a calibration source with an offset. The attenuator (set to 60 dB to 80 dB) is used in the calibration procedure to prevent overloading the low noise amplifier and is set to 10 dB for the measurement on the test oscillator (to maintain linearity in the phase detector). The low pass filter maintains the linearity of the low noise amplifier by preventing overloading. ** An HP 302A Wave Analyzer, in this case with a 1 Hz bandwidth, is swept through the spectrum of interest and the output is integrated and plotted on a Moseley X-Y Recorder.

* V. Van Duzer, "Short-Term Stability Measurements", IV-87, Interim Proceedings of the Symposium on the Definition of Short-Term Frequency Stability; X-521-64-380, Goddard Space Flight Center, NASA, 1964.

** S. Goldman, "Frequency Analysis, Modulation and Noise", McGraw-Hill, New York, 1948.

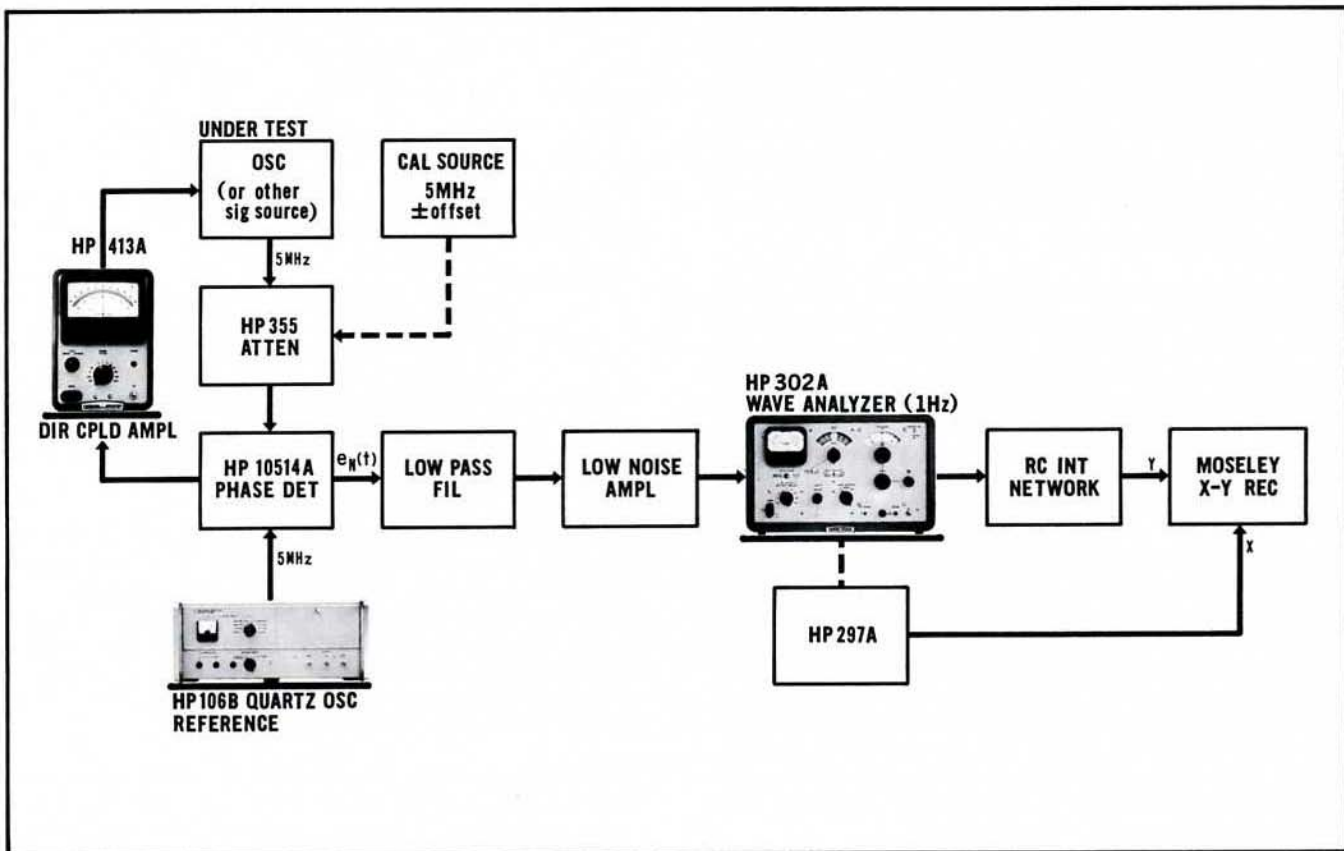

Figure 3-5. Instrumentation setup for plotting phase noise versus frequency offset

The plot obtained on the X-Y Recorder is easily calibrated since A has been determined for e_N and ϕ_N . The sideband amplitude (e_S) at a particular offset frequency (f) can be expressed:

$$e_S = \frac{\phi_{Nf} E_c}{2} = \frac{e_{Nf} E_c}{2A}$$

Since $\phi_{Nf} = \frac{e_{Nf}}{A}$

where:

ϕ_{Nf} = Phase noise at a particular offset frequency.

e_{Nf} = Phase noise analog at a particular offset frequency.

E_c = Main signal amplitude or carrier.

A = Constant

Since it is desirable to express the resultant plot as RMS Phase Noise, and the HP 302A Wave Analyzer is an average reading device that measures noise 1 dB low, a correction of 1 dB must be added to the plot for the RMS correction. The resultant plot may also be

converted to a single-side band phase noise plot by subtracting 6 dB (for a total of minus 5 dB for conversion to a single-sideband RMS phase noise plot). Figure 3-6(a) is a phase noise plot obtained for an HP 5103A 10 MC Frequency Synthesizer using a test setup similar to that shown in Figure 3-5. Figure 3-6(b) is a similar plot converted to single-sideband phase noise versus frequency of offset.

There are advantages in using the phase noise versus offset frequency technique for obtaining short-term stability measurements and spectrum plots. The test setup and calibration procedure is simple and straightforward. The phase noise and spurious in any band of interest may be studied by this measurement procedure. The results obtained will allow the necessary compensations to be made for unwanted noise in any system where the oscillator being tested might ultimately be used.

The measurement technique outlined here is capable of measuring the noise characteristics of the best quartz oscillators available, even at frequencies as low as 1 MHz.

a

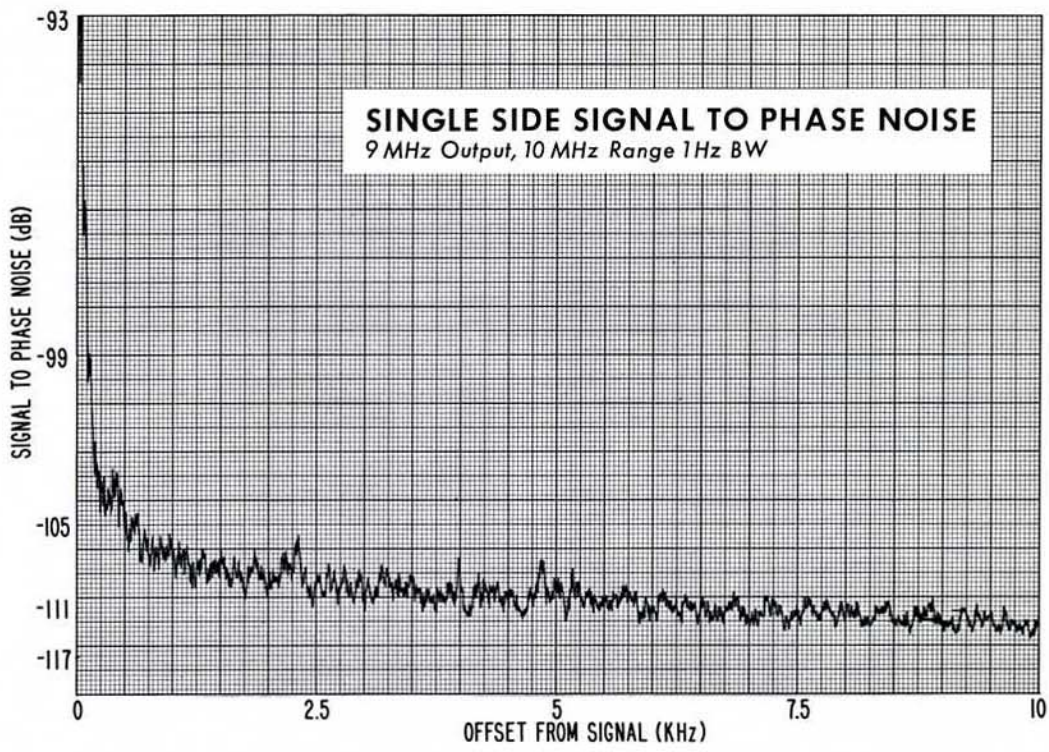

b

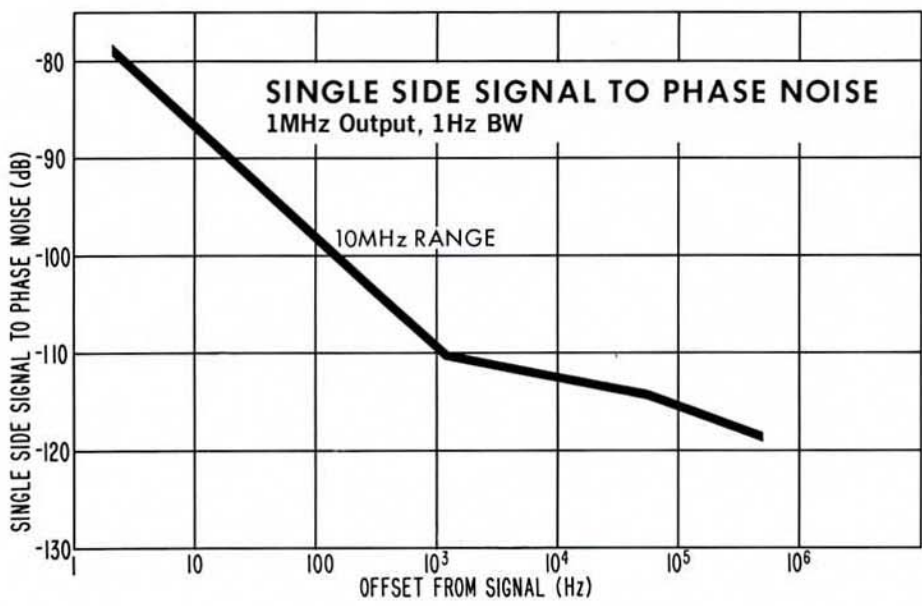
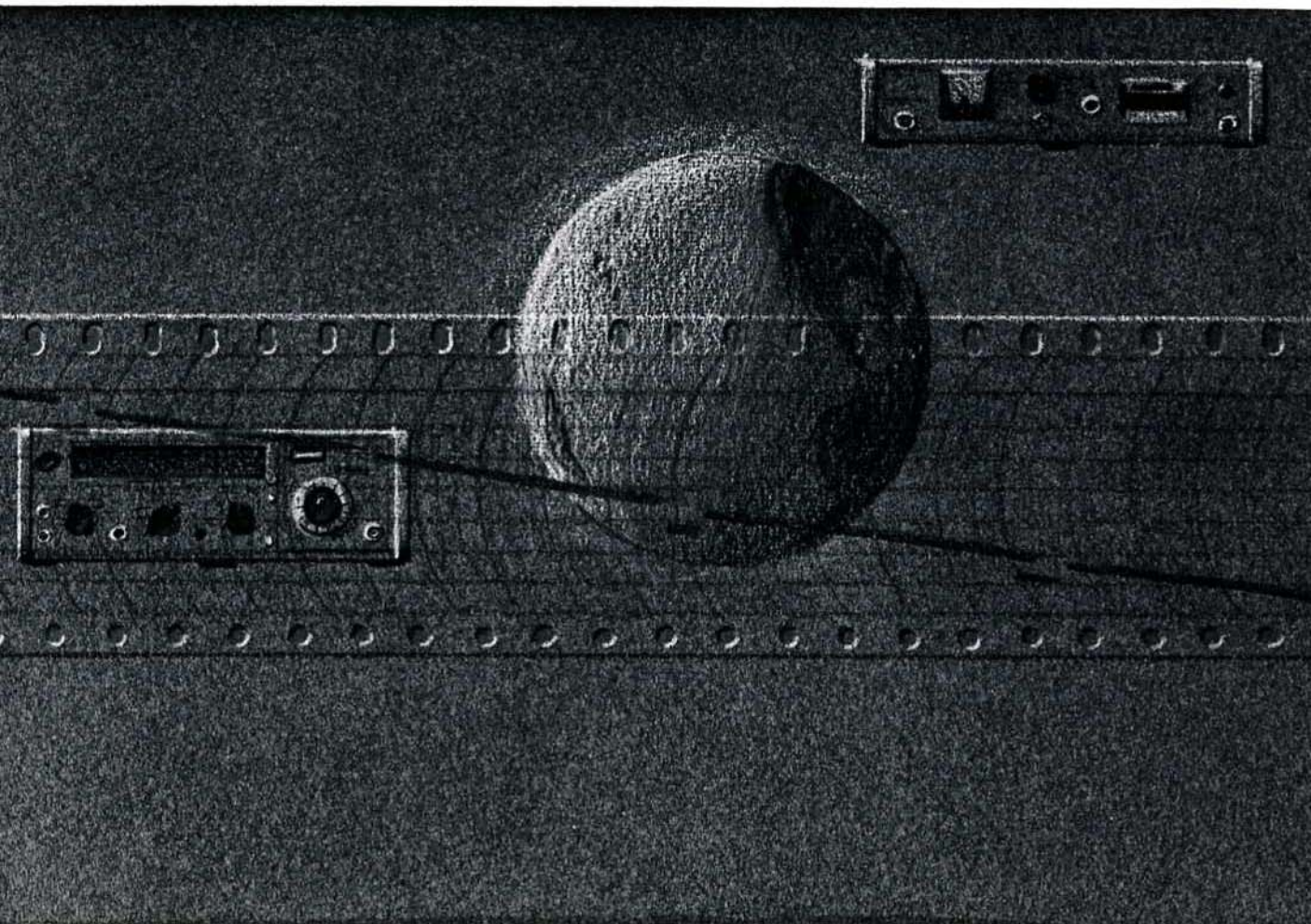

Figure 3-6. 5103A Frequency Synthesizer Phase Noise Plots

SECTION IV
TIME DETERMINATION



SECTION IV

TIME DETERMINATION

1. INTRODUCTION.

For accurate timekeeping, (whether the desired scale be Atomic Time, Universal Time, or any other) it is necessary that the local system (1) provide a consistent time interval, (2) be initially synchronized with the master time, and (3) be checked periodically against the master time to be sure that the scales remain in correspondence.

To maintain a given level of confidence in the local system, comparisons against the time standard must be made at intervals determined by the degree of accuracy and precision of the local system.

A quartz oscillator referred to a cesium beam standard, such as the HP Model 5060A, offers the prime means for maintaining a local time standard of great accuracy and precision. If a quartz oscillator not steered by a cesium beam resonator is the local time standard, then it must be studied for drift rate and changes in drift rate by the preparation of plots such as those described in paragraph 4.

In this section, methods for correlating a local system and maintaining it are discussed.

A. TRANSPORTING A MASTER CLOCK

Time synchronization accuracy to about ± 1 microsecond can be made by transporting a master clock to each clock station. Achieved accuracy depends largely upon the comparison method. The rate (i.e. the daily time gain or loss) and acceleration (i.e. the change in rate) of the master clock must be accurately known and an appropriate correction must be made at each clock station. At the end of the master clock's correlation tour, a time closure is made with the same standard used initially to set it.

In a 1965 experiment conducted through the private resources of Hewlett-Packard, HP cesium beam standards in continuous operation were compared against standards in Japan, Hawaii, Canada, and most of the countries of western Europe.* As a result of this experiment, time scales maintained by time-keeping laboratories separated by intercontinental distances have been correlated within a microsecond, an accuracy far higher than had been possible via high-frequency radio broadcasts (at best, about 1 millisecond).

*L. N. Bodily, "Correlating Time from Europe to Asia with Flying Clocks", *Hewlett-Packard Journal*, Vol. 16, No. 8, April 1965. See also: Bagley and Cutler, "A New Performance of the 'Flying Clock' Experiment", *HP Journal*, Vol. 15, No. 11, July, 1964.

Each of the two "travelling clocks" used in the experiment was an HP Model 5060A Cesium Beam Frequency Standard, an HP Model 115BR Frequency Divider and Clock, and a power supply designed to accept the variety of ac sources found abroad and to supply standby battery power. The clocks were flown some 35,000 miles via commercial airlines.

Two separate comparisons made 23 days apart between the travelling standards and the NBS long-beam cesium standard (NBS II) agreed within 1 part in 10^{12} (about one-half microsecond).

B. HF RADIO TRANSMISSION

Time synchronization accuracy to ± 1 millisecond can be made using presently available standard time signals such as those transmitted by station WWV. With this method the propagation delay between the transmitter and clock station must be determined and then applied as a correction to the clock reading.

The principal factors which affect the propagation delay for HF signals are: (a) the great circle distance between transmitter and receiver, (b) the transmission mode (i.e. the number of earth-to-ionosphere reflections between transmitter and receiver), and (c) the virtual height of the ionospheric reflection layers. A detailed discussion of distance determination is given in paragraph 2, transmission mode and layer height estimation in paragraph 3, and delay determination by graphic means in paragraph 3.

Once the propagation delay has been determined, the Time Reference Control on the clock can be positioned to allow for the delay. The 1-second clock ticks are then produced in synchronism with the transmitted master timing signal.

Example: A clock station (using oscillator-clock-oscilloscope system) located 3100 kilometers (about 10.80 ms transmission delay) from WWV is required to synchronize its clock ticks with the WWV ticks as transmitted. Time-comparison readings are taken when the zero crossing of the second cycle of the received WWV tick is aligned with the vertical center-line of the CRT (1 ms per centimeter sweep speed); the leading edge of the received WWV tick therefore occurs 4 ms after the clock tick (which triggers the oscilloscope). Inspection of the smoothed curve on the time-comparison graph shows that for a particular day, the Time Reference Control on the clock should be set to 231,770 μ s for clock-tick coincidence with the received WWV tick. The time reference setting for synchronization with the transmitted WWV ticks on this day is determined as follows:

Time-comparison graph	231,770 μ s
Reading correction	+ 4,000
Transmission delay	-10,800
Final dial setting	<u>224,970 μs</u>

C. LF-VLF RADIO TRANSMISSION

In addition to the HF time signal services, some of the LF/VLF services broadcast time of day information. These include WWVB, GBR and MSF, and NBA (see Appendix III).

Time ticks of these LF/VLF broadcasts may be used in much the same way as HF broadcasts to set and maintain local time.

The principal limitation in the use of LF/VLF for time of day has to do with system bandwidth considerations. Time pulses are shaped by the relatively high Q's of the transmitter and receiver facilities so that a high degree of resolution on time of day measurements is more difficult than with HF. Furthermore, different low frequency wavelengths propagate with different phase velocities. This causes dispersion of modulated VLF signals that distorts time pulses and places another limitation on the ability to accurately calibrate local clocks.

With the present LF/VLF time services and the receiving equipment now available, time synchronization can probably be accomplished to no better than a few milliseconds. This is somewhat poorer than is the case for HF where careful technique can yield time accuracies of 1 ms. The actual calculations for time of day from LF/VLF time ticks must include the factors of propagation and receiving systems delay in the same way as with HF, except for the simplification made possible by the assumption of all ground-wave transmissions for LF/VLF. VLF waves propagate at about 292,000 km/sec as compared to 278,000 km/sec for HF waves.

Since LF and VLF transmissions are propagated for relatively great distances by ground wave, propagation delay for these frequencies can usually be found directly, after the great circle distance is computed.

D. TWO-WAY RADIO TRANSMISSION

Time synchronization accuracy as good as $\pm 10 \mu$ s can be made using a transponder at the clock station. The propagation delay which the timing pulse undergoes between the master transmitter and the clock station can be accurately determined at the master transmitter from the following relationship:

$$t_{\text{prop}} = \frac{t_{\text{tot}} - t_{\text{tr}}}{2}$$

where t_{prop} = one-way propagation delay between master transmitter and clock station

t_{tot} = total delay at master transmitter between transmission of timing signal and receipt of transponder signal

t_{tr} = delay at the transponder between receipt of timing signal and retransmission of the signal.

Time synchronization by this method requires special transmitting and receiving equipment at both the master time source and the station requiring synchronization and is therefore impractical for most time standard systems.

E. LORAN - C

The Loran-C system, a pulsed radio navigation system* operated on a 100 kHz carrier by the U. S. Coast Guard, offers a means for precision transfers of time. Clock synchronization to $\pm 1 \mu$ s is possible within range of any station of the East Coast Loran-C chain. The master east coast station at Cape Fear, N. C., is controlled with respect to an atomic clock at the U. S. Naval Observatory.

F. SATELLITE TIME SYNCHRONIZATION

Experiments in time transfers by use of satellites have shown that clocks can be synchronized to high precision at facilities equipped with satellite tracking antennas. One of the most recent experiments was conducted with the NASA satellite Relay II.**

The U. S. Naval Observatory and the Radio Research Laboratories of Tokyo jointly carried out experiments that correlated clocks at satellite tracking stations at Mojave, California and at Kashima, Japan. As part of these experiments, Hewlett-Packard cesium beam clocks were flown from Washington D. C. to Mojave to Kashima and back. Preliminary results indicate that clocks can be synchronized with use of satellites to within a microsecond.

An earlier (1962) experiment*** correlated to an accuracy of $\pm 1 \mu$ s time kept by the master clock at the U. S. Naval Observatory in Washington, D. C., and that of the U. K.'s Royal Greenwich Observatory at Herstmonceux, England. Pulsed signals were transmitted simultaneously over the satellite circuit from ground stations at Andover, Maine and at Goonhilly Downs, Cornwall. Low frequency ground wave signals propagating with known velocities extended the signals to the observatories.

2. COMPUTATION OF THE GREAT-CIRCLE DISTANCE

A. METHOD OF HAVERSINES

A quick way to compute the great circle distance between two points utilizes haversines. Suppose A and B are two points on earth for which latitude and longitude are known. As the first step in the computation, certain relationships of their latitudes and longitudes are found.

*Wm. Markowitz, "The Atomic Time Scale", IRE Trans. on Instr., Dec. 1962, p. 239. See also Doherty, et al, "Timing Potentials of Loran C", Proc. IRE 49, Nov. 1961, p. 1659.

**W. Markowitz and C.A. Lidback, "Clock Synchronization via Relay II, Prelim. Report", Proc. 19th Symposium on Frequency Control, 1965 (to be published). See also "Frequency Control Symposium", Frequency, May-June 1965, page 13, and Bodily, L.N., "Correlating Time from Europe to Asia with Flying Clocks", Hewlett-Packard Journal 16, 8 (April 1965).

***J.A. McA. Steel, Wm. Markowitz, and C.A. Lidback, "Telstar Time Synchronization", Conf. on Precision Electromagnetic Measurements, June 1964, to be published in IEEE Trans. on Instr. and Meas.

For longitude:

$$Lo_{AB} = Lo_A - Lo_B$$

where:

Lo_A = longitude of point A

Lo_B = longitude of point B

For latitude, if the two points are on the same side of the equator:

$$L_{AB} = L_A - L_B$$

where:

L_A = latitude of point A

L_B = latitude of point B

If the two points lie on opposite sides of the equator:

$$L_{AB} = L_A + L_B$$

The haversine of the great circle distance, in degrees of arc, is then given by:

$$\begin{aligned} \text{hav } D &= (\cos L_A) (\cos L_B) (\text{hav } Lo_{AB}) \\ &+ \text{hav } L_{AB} \end{aligned}$$

Great Circle Distance D may be determined by reference to the table of haversines vs. angles which is included in Appendix IV. Figure 4-1 shows the quantities to which reference has been made.

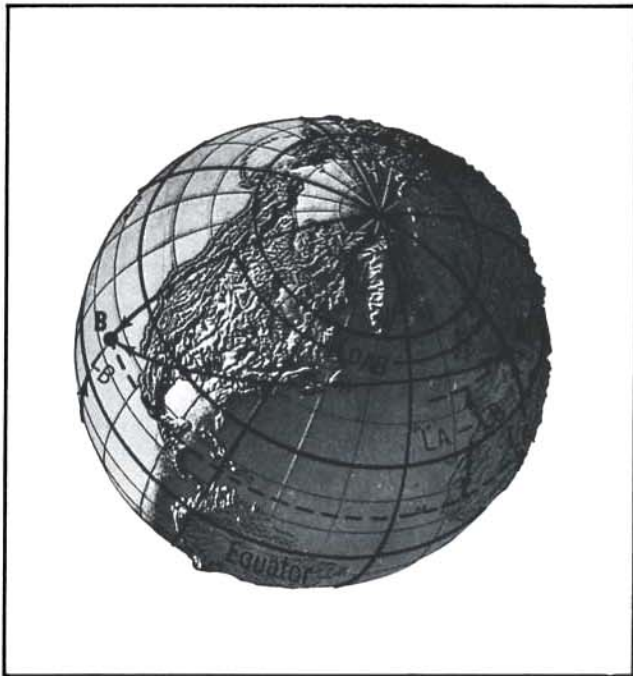

Figure 4-1. Great circle distance calculation

Note: The haversine of angle $\theta = 1/2$ versine $\theta = 1/2 (1 - \cos \theta) = \sin^2 1/2 \theta$; also, $\text{hav } \theta = \text{hav } (360^\circ - \theta)$; thus, $\text{hav } 210^\circ = \text{hav } 150^\circ$

Computations made using haversine and cosine tables in Appendix IV are sufficiently accurate for most sky-wave propagation delay estimates. Distance errors of as much as 10 to 20 miles contribute less error to the delay estimate than is expected to result from errors in estimating propagation mode and ionospheric height. A more extensive haversine table permitting distance calculation to within a mile is given in Bowditch, American Practical Navigator, Part II, U. S. Government Printing Office, Washington 25, D. C.

Example: Find the distance between radio station WWV (point A), $39^\circ 00'N$ $76^\circ 51'W$, and Palo Alto, California (point B), $37^\circ 23'N$ $122^\circ 09'W$.

$$L_A = 39^\circ 00'N$$

$$L_B = 37^\circ 23'N$$

$$Lo_{AB} = 45^\circ 18'$$

$$L_A - L_B = 1^\circ 37'$$

$$\log \cos L_A = \log \cos 39^\circ 00' = 9.8905 - 10$$

$$\log \cos L_B = \log \cos 37^\circ 23' = 9.9001 - 10$$

$$\log \text{hav } Lo_{AB} = \log \text{hav } 45^\circ 18' = \frac{9.1712 - 10}{8.9618 - 10}$$

Taking antilog from haversine table, log hav to nat hav:

$$\text{antilog } 8.9618 - 10 = 0.0916$$

$$\text{hav } (L_A - L_B) = \text{hav } 1^\circ 37' = \frac{0.0002}{0.0918}$$

$$D = \text{arc hav } 0.0918 = 35^\circ 17'$$

Since $1'$ of arc = 1 nautical mile = 1.151 statute miles = 1.852 kilometers, then $35^\circ 17' = 2117$ nautical miles = 2439 statute miles = 3923 kilometers.

B. NOMOGRAPH

A nomograph which can be used to estimate the great circle distance between two points is presented in Appendix IV. This nomograph represents a graphical solution to the equation:

$$\begin{aligned} \text{hav } D &= (\cos L_A) (\cos L_B) (\text{hav } Lo_{AB}) + \\ &\text{hav } L_{AB} \end{aligned}$$

The dashed line on the nomograph traces the path followed in solving the same example problem discussed in Paragraph A.

3. TRANSMISSION MODES

The ground-wave propagation path (most LF/VLF transmissions and short-distance HF transmissions) closely follows the great-circle route between the transmitter and receiver. However, HF transmissions over a distance of more than about 160 kilometers follow sky-wave paths.

A. MULTIPLE HOPS

The maximum distance that can be spanned by a single hop (i.e. one reflection from the ionosphere) via the F2 layer is about 4000 km (Figure 4-2). Therefore, the fewest number of hops between transmitter and receiver is the next integer greater than the great-circle distance (in kilometers) divided by 4000. Transmission modes with one or two more hops than the minimum number of hops occur frequently (Figure 4-4), but modes of higher order are greatly attenuated during transmission and are of little concern.

Example 1: Find the minimum number of hops for a distance of 3923 km.

Solution: A one-hop F2 mode is possible ($3923 \div 4000 < 1$).

Example 2: What modes are likely to be received at a distance of 7687 km?

Solution: Two-hop, three-hop, and four-hop F2 modes can be expected ($7687 \div 4000 > 1$, but < 2).

Useful transmissions via the E layer (daytime only) are usually limited to one-hop modes up to a distance of about 2400 km.

Remember that some locations may receive transmissions from both the E and F2 layers and that transmissions may be reflected occasionally from layers other than the E and F2.

The following approach should improve your estimate of propagation delay:

1) Determine which modes are possible at your location.

2) Tune to the highest frequency which provides consistent reception to reduce interference from high-order modes.

3) If several modes are being received (indicated by multiple tick reception or tick jitter between fairly constant positions), select the tick with earliest arrival time for measurements.

4) After plotting time measurements for several weeks, either disregard measurements which are conspicuously out of place, or correct the measurement to the more likely mode if the plot is mistimed by the difference in time between possible modes.

B. HEIGHT OF IONOSPHERE

Long-distance HF transmissions are usually reflected from the F2 layer, which varies in height from about 250 to 450 km. Experience has shown that the virtual height of the F2 layer averages about 350 km (Figure 4-3). Unless special studies permit determination of layer height, 350 km can be used for delay estimation.

The E layer exists only during the daytime at a virtual height of about 125 km (Figure 4-3). One-hop E modes may provide very steady daytime reception at distances up to about 2400 km.

C. DELAY DETERMINATION

Once the transmitter-to-receiver distance, possible transmission modes, and layer heights have been determined, transmission delay can be found graphically from Figure 4-2. The shaded area along the F2 curve shows the possible extremes of height variation.

As shown in the following examples, the delay for a one-hop mode can be read directly from the transmission delay graph for a given distance and layer height.

Example 1: Find the one-hop delay for a distance of 3923 km.

Solution: Expected F2 delay is about 13.60 ms. No one-hop E mode is likely since the distance is greater than the usual limit of 2400 km for the one-hop E mode.

Example 2: Find the one-hop delay for a distance of 2200 km.

Solution: Expected F2 delay is about 7.90 ms; expected E delay is about 7.50 ms.

For a multi-hop mode, (a) determine the distance covered by each hop, (b) find the delay for a single hop, then (c) multiply the single-hop delay by the number of hops to determine the total delay.

Example 3: Find the two-hop delay for a distance of 3923 km.

Solution: Each 1962-km hop contributes a delay of about 7.15 ms; the total delay is 7.15×2 or 14.30 ms. Note that the two-hop delay for a 3923-km distance is 0.7 ms greater than the one-hop delay for the same distance determined in Example 1 above.

Example 4: Find the three-hop delay for a distance of 7687 km.

Solution: The delay contributed by each 2562-km hop is about 9.05 ms; the total delay is 9.05×3 or 27.15 ms.

Example 5: Find the four-hop delay for a distance of 7687 km.

Solution: The delay contributed by each 1922-km hop is about 6.95 ms; the total delay is 6.95×4 or 27.80 ms. Note that the four-hop delay for 7687-km distance is 0.65 ms greater than the three-hop delay for the same distance determined in example above.

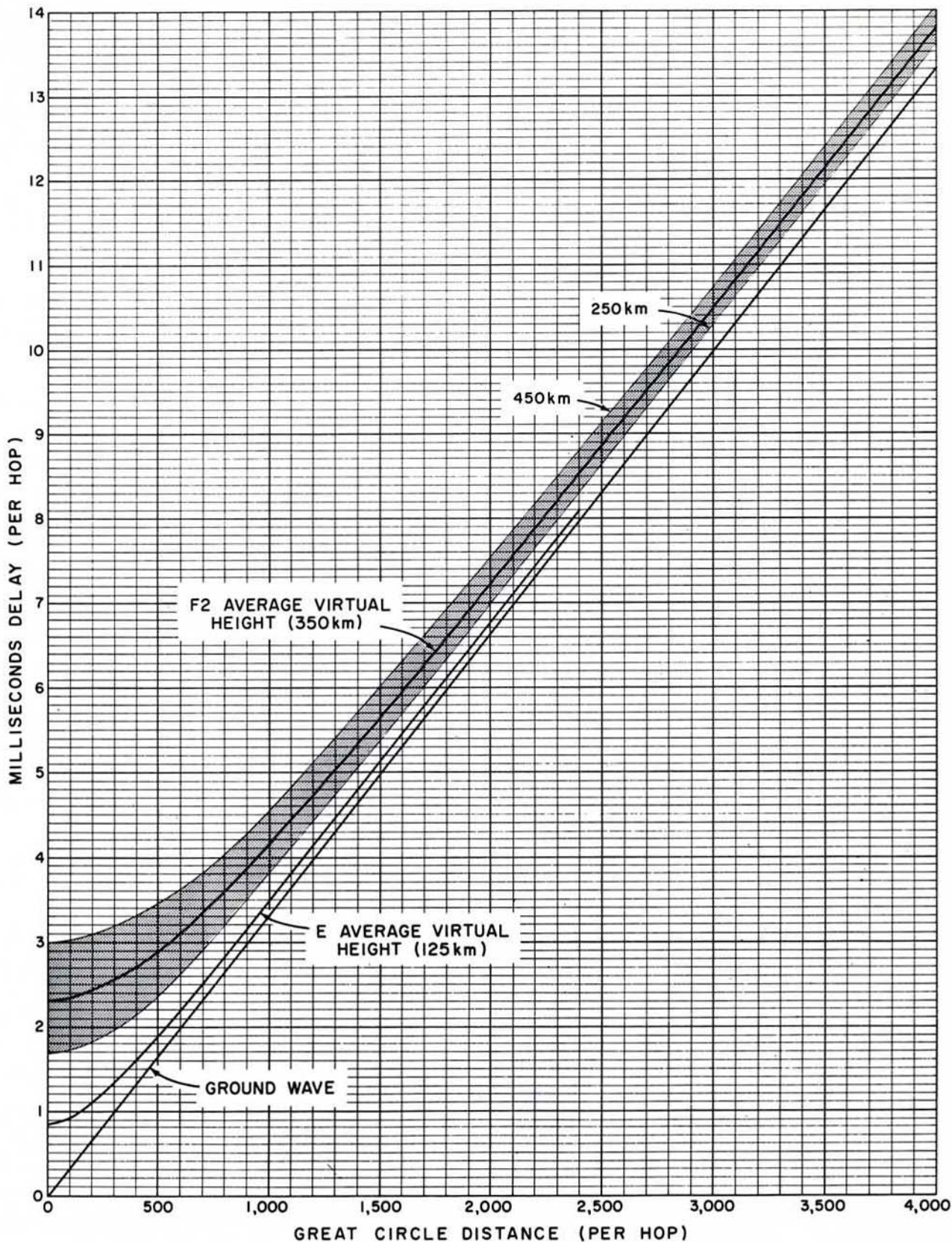

FROM A.H. MORGAN, TIME SYNCHRONIZATION OF WIDELY SEPARATED CLOCKS.

Figure 4-2. Transmission Delay Graph

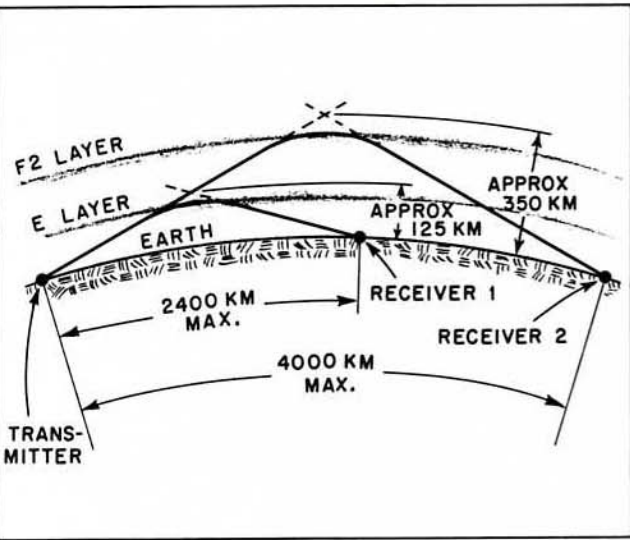

Figure 4-3. Single-hop sky-wave paths

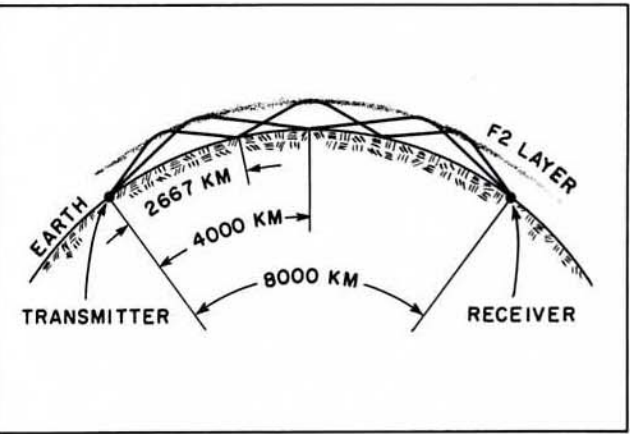
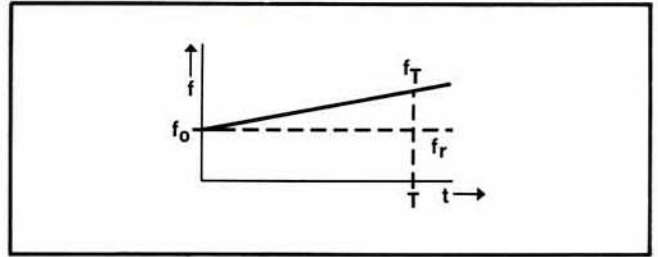

Figure 4-4. Multiple-hop transmission path

A. TIME ERROR VS. FREQUENCY

The frequency at any time t can be expressed (with the rate of frequency shift approximated by a straight line):

$$f_t = f_o + af_r t$$



Where: f_t = frequency at time t

f_o = initial frequency at time $t=0$

f_r = reference frequency (standard)

a = aging rate

Now, since f_t differs by a small amount from f_r , the clock, based upon this oscillator, will gain or lose time because each oscillator cycle is a little short or long. In the case illustrated by the sketch, f_t is increasing with respect to f_r ; the time of each cycle the oscillator makes is short by an amount L .

$$L = \frac{1}{f_r} - \frac{1}{f_t}$$

In an arbitrarily short time Δt , there are $f_t \Delta t$ cycles.

The incremental time error ΔE can be written:

$$\Delta E = \left(\frac{1}{f_r} - \frac{1}{f_t} \right) f_t \Delta t$$

Taken to the limit,

$$dE = \left(\frac{1}{f_r} - \frac{1}{f_t} \right) f_t dt = \left(\frac{f_t}{f_r} - 1 \right) dt$$

To obtain E ,

$$E = \int \frac{f_t}{f_r} dt - \int dt$$

But: $f_t = f_o + af_r t$

Therefore,

$$E = \int \frac{f_o + af_r t}{f_r} dt - \int dt = \int \frac{f_o}{f_r} dt + \int at dt - \int dt$$

$$E = \frac{f_o}{f_r} t + \frac{at^2}{2} - t + C$$

4. RELATION OF TIME ERRORS TO FREQUENCY DRIFT

A time system based upon a quartz oscillator of known drift rate can be kept within prescribed limits of error with but infrequent adjustments through use of a systematic approach to be discussed.

In this approach, the oscillator and clock are preset to offsets that will keep the time system operating within a selected accuracy for a long time despite the oscillator's drift. This drift (aging rate) must be known and must be nearly constant, so that the frequency can be approximated by a straight line. In what follows, it will be assumed that the oscillator's aging rate has been established by comparisons of the oscillator against a standard.

The basic equations are presented first, then the method is illustrated with a problem solved by calculation and by chart.

At $t=0$, $C=E_0$, the initial error. The total time error E is:

$$E = E_0 + \left(\frac{f_0}{f_r} - 1 \right) t + \frac{at^2}{2} \quad \text{Eq. 1}$$

Eq. 1 indicates that the total time error at any time t depends upon the values of four quantities: (1) initial time error, E_0 ; (2) initial frequency f_0 ; (3) oscillator aging rate, a ; and (4) elapsed time, t .

A plot of Eq. 1 as a function of time is a parabola for which vertical displacement depends upon the value of E_0 . The corresponding frequency plot is shown beneath the error plot.

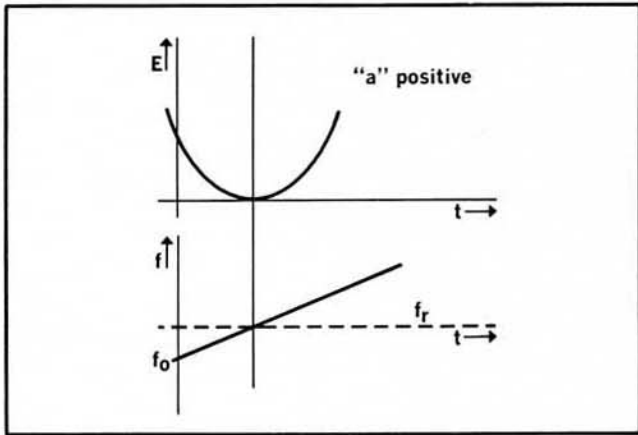

Note that the oscillator frequency is precisely equal to the reference frequency at the point corresponding to the vertex of the error parabola. This is as it should be, for the slope of the error curve must be zero where the two frequencies agree.

If the frequency drift were negative, the parabola would be inverted:

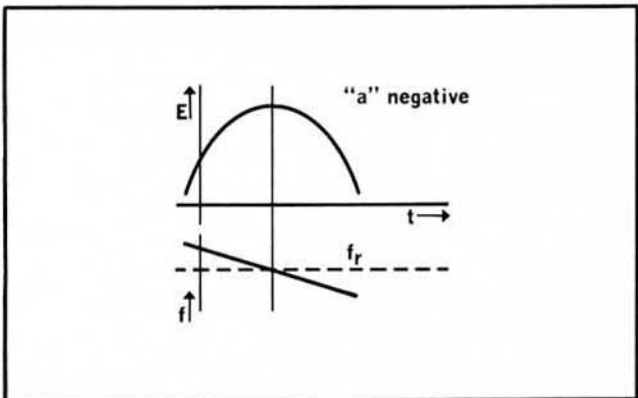

Figure 4-5 shows corresponding plots of frequency and time error to clarify their relationship.

B. EXAMPLE

Now, as a specific problem, suppose a time system is to be maintained within 10 ms. The 1 MHz oscillator that drives the clock is known to have a positive drift rate, "a", of 5×10^{-10} parts/day. (a) What must be the initial time error (E_0) set on the clock? (b) What must be the initial frequency offset (f_0)? (c) What is the length of the recalibration cycle (T_2), number of days the oscillator is left untouched between resettings.

The elapsed time during which the error of the clock is less than 10 milliseconds can be maximized by

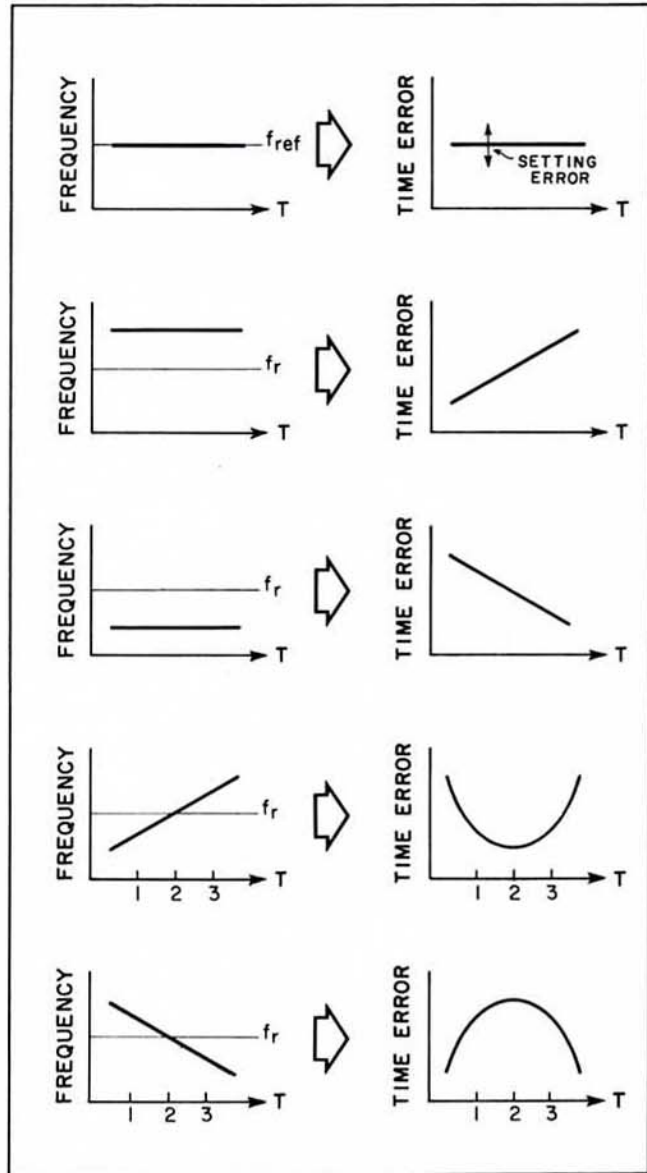
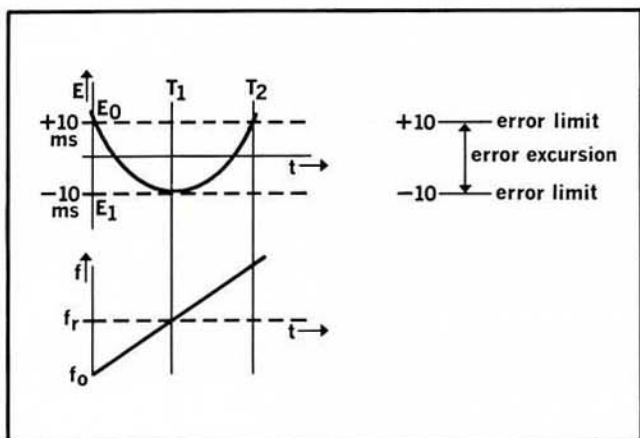

Figure 4-5. Corresponding frequency and time plots

selection of initial conditions such that the error plot and the frequency plot are situated thus:



In the sketch, $t = T_1$ when the time error plot has a slope of zero. The parabola was positioned vertically such that its vertex at T_1 does not exceed the selected error limit, -10 ms. This was accomplished by setting E_0 , the initial error, at the other error limit, $+10$ ms. We now have answer (a): $E_0 = +10$ ms.

Also, the oscillator frequency was initially set to a certain offset. These two steps maximize the elapsed time T_2 during which the system lies within the selected limits of error.

The general equation (Eq. 1) is now solved for f_0 and T_2 .

$$E = E_0 + \left(\frac{f_0}{f_r} - 1 \right) t + \frac{at^2}{2}$$

At time $t = T_1$, $E = E_1$

$$E_1 = E_0 + \left(\frac{f_0}{f_r} - 1 \right) T_1 + \frac{aT_1^2}{2}$$

But $E_1 = -E_0$, therefore:

$$-E_0 = E_0 + \left(\frac{f_0}{f_r} - 1 \right) T_1 + \frac{aT_1^2}{2}$$

$$0 = 2E_0 + \left(\frac{f_0}{f_r} - 1 \right) T_1 + \frac{aT_1^2}{2} \quad \text{Eq. 2}$$

There are two unknowns, T_1 and f_0 . Since the slope is known to be zero at $t = T_1$:

$$\frac{dE}{dt} = 0 \quad \text{at} \quad t = T_1$$

From Eq. 1,

$$E = E_0 + \left(\frac{f_0}{f_r} - 1 \right) t + \frac{at^2}{2}$$

$$\frac{dE}{dt} = 0 = \frac{f_0}{f_r} - 1 + \frac{a}{2} (2T_1) = \frac{f_0}{f_r} - 1 + aT_1$$

$$aT_1 = 1 - \frac{f_0}{f_r}$$

$$\frac{f_0}{f_r} = 1 - aT_1$$

Eq. 3

Substituting into Eq. 2:

$$\begin{aligned} 0 &= 2E_0 + \left(1 - aT_1 - 1 \right) T_1 + \frac{aT_1^2}{2} \\ &= 2E_0 - \frac{aT_1^2}{2} \end{aligned}$$

$$-4E_0 = -aT_1^2$$

$$T_1^2 = \frac{4E_0}{a}$$

$$T_1 = 2 \sqrt{\frac{E_0}{a}}$$

Eq. 4

The parabola is symmetrical about T_1 :

$$T_2 = 2T_1$$

Hence, T_2 in terms of the initial error E_0 and the drift rate a , is:

$$T_2 = 4 \sqrt{\frac{E_0}{a}} \quad \text{Eq. 5}$$

To solve the example problem numerically, we first convert milliseconds to days:

$$\begin{aligned} E_0 &= 10 \text{ ms} \times \frac{\text{day}}{8.64 \times 10^4 \text{ sec}} \times \frac{\text{sec}}{10^3 \text{ ms}} = \\ &0.116 \times 10^{-6} \text{ day} \end{aligned}$$

$$T_2 = 4 \sqrt{\frac{1.16 \times 10^{-7}}{5 \times 10^{-10}}} = 4 \sqrt{2.32 \times 10^2} =$$

60.8 days

Answer (c)

The oscillator can operate for 60.8 days without recalibration. It remains to discover what the oscillator's initial offset must be. From Eq. 3.

$$\frac{f_o}{f_r} = 1 - aT_1$$

$$f_o = f_r (1 - aT_1)$$

But

$$T_1 = \frac{T_2}{2} = 30.4 \text{ days}$$

$$f_o = f_r \left[1 - (5 \times 10^{-10})(30.4) \right] =$$

$$f_r (1 - 152 \times 10^{-10}) \quad \text{Answer (b)}$$

It is clear that the oscillator must be set to a frequency lower than reference frequency by 152 parts in 10^{10} .

C. RECALIBRATION CHART

Figure 4-6 is a chart useful for estimating the length in days of the recalibration cycle for an oscillator with known drift rate to keep the time system based on it within prescribed error limits. A recalibration cycle is the time, in days, that can be allowed to pass between calibration adjustments. A shorter cycle (more frequent adjustment) is needed to keep a system accurate to ± 10 ms (total time excursion, $2E_o = 20$ ms) than to, say, 50 ms.

To use the chart, select the slant line marked for the aging rate (in parts per day) of the oscillator in question. Note the intersection of this line with the horizontal line corresponding to the permitted error excursion (in ms). This intersection, referred down to the horizontal axis, gives the recalibration cycle (in days).

For example, the previous problem involved a time system to be maintained to within 10 ms based on an oscillator with a positive drift rate $a = 5 \times 10^{-10}$ parts/day. To use the chart to estimate the length of the recalibration cycle, locate the slant line marked " 5×10^{-10} parts/day" and note its intersection with the horizontal line corresponding to a total time excursion of 20 ms (± 10 ms). The answer read from the chart is 58 days (computed answer, 60.8 days). Note that to use this chart, aging rate must be expressed in parts/day, and permitted time excursion, in milliseconds.

This chart provides graphical solutions to the equation:

$$T_2 = 4 \sqrt{\frac{E_o}{a}}$$

where: T_2 = number of days between oscillator recalibrations

E_o = error limit, ms

a = drift rate, parts/day

To obtain a straight-line plot, this equation is placed in slope-intercept form ($y = mx + b$):

$$T_2 = 4 \sqrt{\frac{E_o}{a}}$$

$$T_2^2 = 16 \frac{E_o}{a} = \frac{8}{a} (2E_o)$$

$$2E_o = \left(\frac{a}{8}\right) T_2^2$$

$$\log (2E_o) = 2 \log T_2 + \log \frac{a}{8}$$

The log-log plot is a line with slope = 2 and intercept = $\log \frac{a}{8}$. For selected values of "a", Figure 4-6 shows the region of interest.

To calculate the oscillator's frequency offset f_o , it is necessary to know T_1 . This value is easily computed from the value of T_2 which has been read from the chart:

$$T_1 = \frac{T_2}{2} = \frac{60}{2} = 30 \text{ days}$$

$$f_o = f_r (1 - aT_1) = f_r \left[1 - (5 \times 10^{-10})(30) \right]$$

$$= f_r \left[(1 - 150 \times 10^{-10}) \right]$$

Frequency offset is, then, -150 parts in 10^{10} .

D. DRIFT RATE PREDICTION

It should be recognized that unless the drift rate actually is the one predicted for the oscillator, use of this method may enlarge rather than minimize error. Figure 4-7 shows this effect.

In a typical case, frequency drift was assumed to be 3×10^{-10} parts per day (heavy solid line); the initial frequency was offset -150 parts in 10^{10} and the initial time was offset 16 ms to minimize error over a 100-day period. The plots of Figure 4-7 show the increased time error that would result if oscillator performance were at a drift rate other than the 3 parts in 10^{10} predicted, say, at 1, 2, 4, or 5 parts in 10^{10} .

5. FREQUENCY DETERMINATION FROM TIME COMPARISONS

A. GENERAL

Before stabilized LF/VLF transmissions were available for use in a quick and accurate calibration of a local frequency standard, it was common practice to use time ticks from a high frequency standard station such as WWV for this purpose. This time comparison method for determining frequency has fallen into disuse because it is neither quick nor convenient. In those rare cases where no access exists to LF/VLF standard signals this method could still serve.

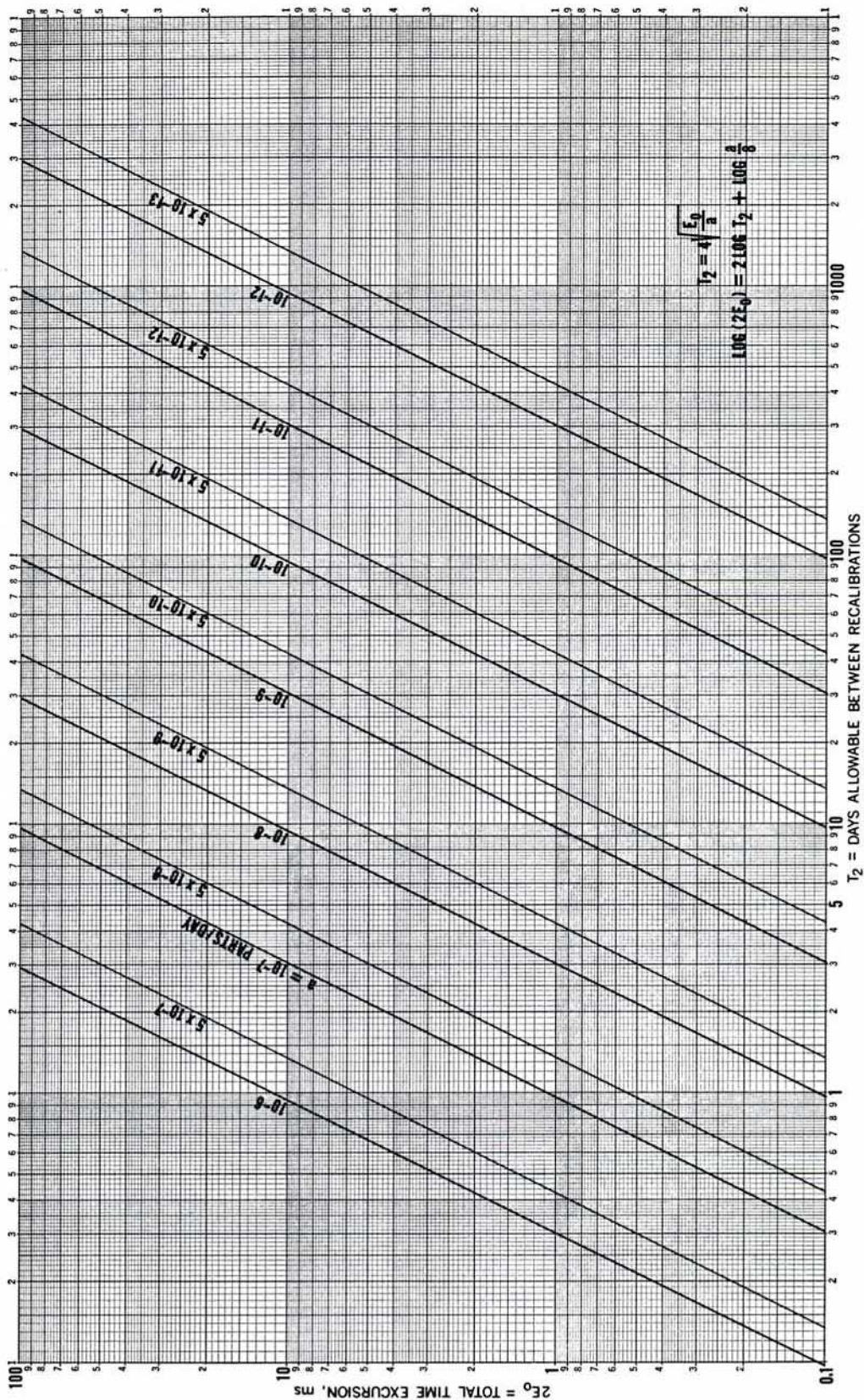

Figure 4-6. Chart to estimate the recalibration cycle for an oscillator

In the time comparison method, frequency is measured indirectly. Observations are made over an extended period of time in order to minimize errors arising from variations in propagation; overall accuracy depends on signal conditions and on the length of the test.

such as those described in Section II. If the time intervals of the local clock precisely match those of the master clock, oscillator frequency is precisely its nominal value. If the clock loses time, oscillator frequency is low; if it gains time, oscillator frequency is high.

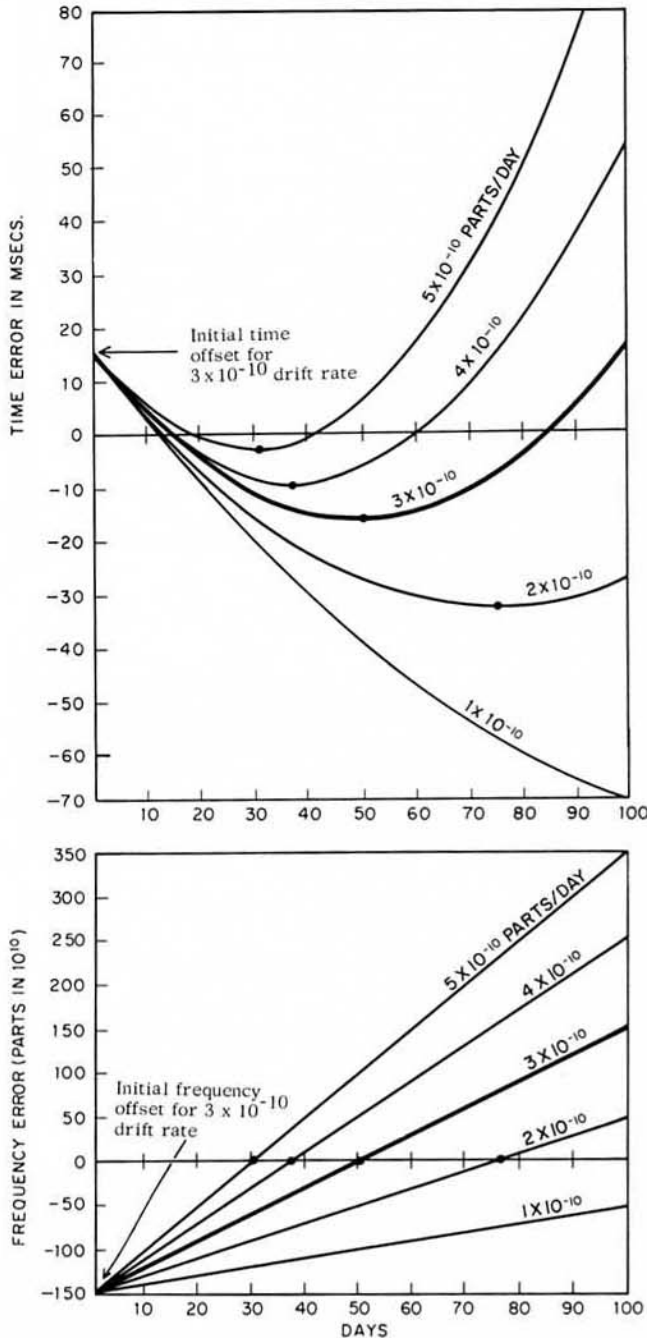

Figure 4-7. Error Plots

Suppose the local clock is a synchronous motor driven by a precision oscillator and that its time is periodically compared with the master time by methods AN-52

B. DIRECT COMPUTATION

The average oscillator frequency (or average frequency error) during the elapsed time between two time comparison measurements is easily computed. Since the drift rate for a precision oscillator is nearly constant, the average frequency during a single time span can be considered equal to the instantaneous frequency at the midpoint of the span. (Note: Section IV-4 discussed fully the relation of time errors to frequency drift.)

Average fractional error in frequency is equal to the fractional time error and is given by

$$\frac{\Delta f}{f} = \frac{t_2 - t_1}{T}$$

where $\frac{\Delta f}{f}$ = average frequency error

t_1 = initial time-comparison reading

t_2 = final time-comparison reading

T = elapsed time between readings.

Example: A time comparison reading at 10:00 a.m. on June 1 is 563,060 μ s; a reading at 10:00 a.m. on June 4 is 564,040 μ s. In this case,

$$\begin{aligned} \frac{\Delta f}{f} &= \frac{564,040 \mu\text{s} - 563,060 \mu\text{s}}{3 \text{ days}} \\ &\times \frac{1 \text{ day}}{8.64 \times 10^{10}} = \frac{+ 3.8}{10^9} \end{aligned}$$

That is, the average oscillator error during this period (or, assuming constant frequency drift, the instantaneous error at 10:00 p.m. on June 2) is 3.8 parts in 10^9 high.

Average frequency of an oscillator during the measurement interval is given by

$$f_{av} = f_{nom} \left(1 + \frac{\Delta f}{f} \right)$$

where f_{av} = average frequency

f_{nom} = nominal oscillator frequency

$\frac{\Delta f}{f}$ = average frequency error.

DAY	TIME REFERENCE	
	MILLISEC	MICROSEC
0	293	700
7	290	680
14	290	680
28	292	190
35	295	810

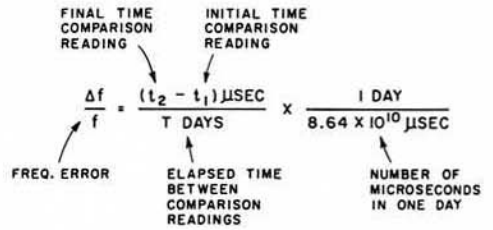

A FREQ. ERROR FIRST WEEK

$$\frac{\Delta f}{f} = \frac{(290\ 680 - 293\ 700)\ \mu\text{SEC}}{7\ \text{DAYS}} \times \frac{1\ \text{DAY}}{(8.64 \times 10^{10})\ \mu\text{SEC}} = -50 \times 10^{-10}$$

B FREQ. ERROR SECOND WEEK

$$\frac{\Delta f}{f} = \frac{290\ 680 - 290\ 680}{7} \times \frac{1}{8.64 \times 10^{10}} = 0$$

C FREQ. ERROR THIRD WEEK

$$\frac{\Delta f}{f} = \frac{292\ 190 - 290\ 680}{7} \times \frac{1}{8.64 \times 10^{10}} = +25 \times 10^{-10}$$

D FREQ. ERROR FOURTH WEEK

$$\frac{\Delta f}{f} = \frac{295\ 810 - 292\ 190}{7} \times \frac{1}{8.64 \times 10^{10}} = +60 \times 10^{-10}$$

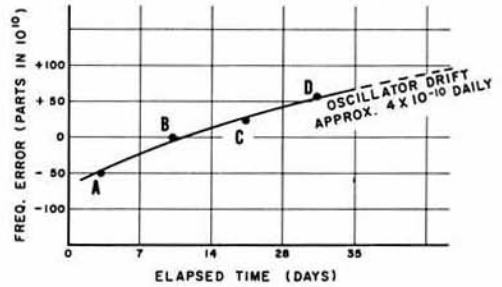

Figure 4-8. Direct Frequency Plot

Continuing with the example given before for an oscillator with a nominal frequency of 1 MHz,

$$f_{av} = 10^6 \left(1 + \frac{3.8}{10^9}\right) = 1,000,000.0038\ \text{Hz}$$

Note that determination of oscillator frequency depends on measurement of time intervals, and does not depend on absolute time setting or time synchronization with the master time source. Figure 4-8 shows an example of a direct frequency plot (based on data taken over a time span of about a month) which could be used to estimate oscillator frequency at any given time.

C. SLOPE OF TIME - ERROR CURVE

A plot of time comparison readings can be used to determine frequency error. This plot eliminates the need for daily frequency error computations. The slope of the time error curve at a selected time equals the instantaneous oscillator error at that time.

An example of a time comparison plot used to find oscillator frequency error is shown in Figure 4-9.

To find oscillator frequency error, draw a smooth curve through the daily time-comparison plots. Draw a line tangent to the curve at the time for which the

instantaneous frequency is required. Choose a convenient segment of the tangent line and divide its time error (projection on the TIME REFERENCE scale) by its elapsed time (projection on the ELAPSED TIME scale). The quotient (using the relationship 8.64×10^{10} microseconds = 1 day to cancel units of measurement) is the oscillator frequency error.

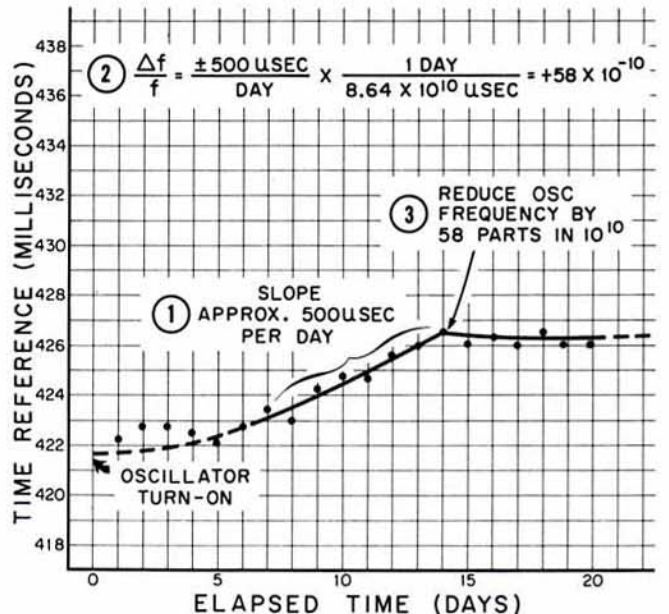

Figure 4-9. Time Comparison Plot

Time-comparison measurements permit determination of average oscillator error during a time interval which has already occurred. Present and future frequency error can be estimated graphically by extrapolation.

Oscillator frequency can be maintained within pre-selected limits by use of a technique which is in many

respects the dual of that described in Section IV-4 to maintain a time system. A time comparison plot is made and that slope determined which represents maximum allowable oscillator error. Oscillator frequency is readjusted when the time-error curve reaches this slope. Examples of the use of this technique are shown in Figure 4-10.

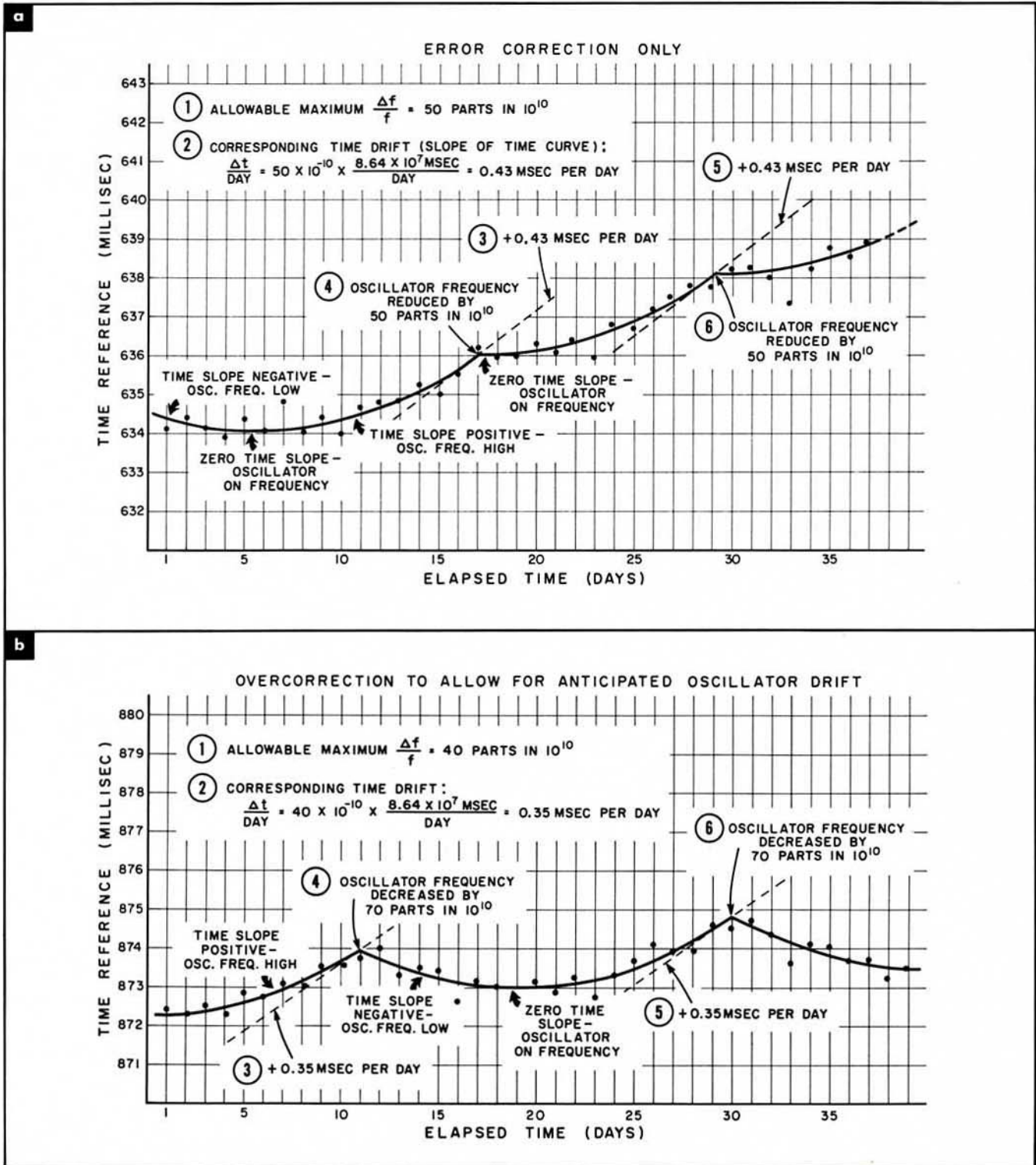
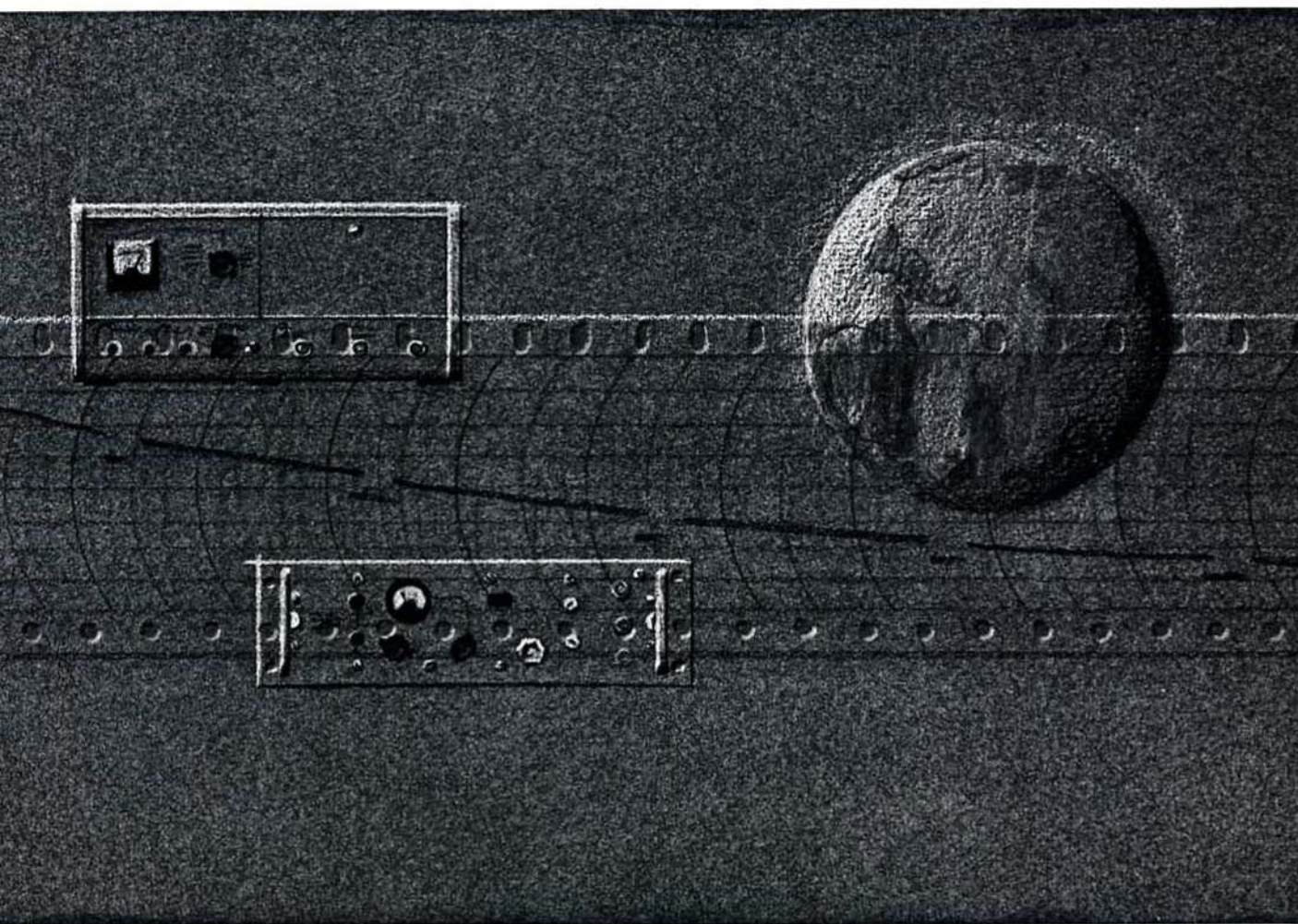

Figure 4-10. Slope-Limit Frequency Control

SECTION V

**STABILITY AND SPECTRAL
PURITY IN FREQUENCY
STANDARDS**



SECTION V

STABILITY AND SPECTRAL PURITY IN FREQUENCY STANDARDS

1. GENERAL

A frequency standard must provide a stable, spectrally pure signal if it is to yield a narrow spectrum after multiplication to the microwave region. HP precision quartz crystal oscillators are carefully designed to produce just such a signal, one capable of large multiplication with minimum degradation of the spectrum (for example, an HP Model 106A, B quartz oscillator gives spectra only a few hertz wide in the microwave region by multiplication of its 5 MHz output).

The need for pure signals in the microwave region has grown with recent developments in microwave spectroscopy, because stable, pure signals are needed to excite the desired transitions between energy states. Atomic resonator frequency standards, as discussed earlier, utilize injected microwave energy with frequencies corresponding to the energy level separations of the states involved. The high signal-to-noise ratio requirements for quality communications systems have long been met by specification of narrow bandwidths, which in turn require stable, narrow-band signals.

A good frequency standard is characterized by good stability, both long term and short term. The quality of a precision quartz oscillator is usually expressed in terms of long and short term stability. Long term stability refers to slow changes with time in average frequency, arising usually from secular changes in the resonator or other elements of the oscillator. Long term stability is sometimes called aging rate and usually is expressed in fractional parts per unit time, as "3 parts in 10^9 per day". Short term stability refers to changes in average frequency over a time span sufficiently short that long term effects may be neglected. Short term stability specifications are presented in a variety of ways, some of which unfortunately make interpretation difficult and intercomparison difficult. It is Hewlett-Packard's practice to avoid ambiguity by a clear specification in terms of fractional frequency deviation and a stated averaging time.

This section discusses a few of the considerations involved in the design of a quartz oscillator meeting high spectral purity and stability requirements.

2. FACTORS AFFECTING STABILITY

A high-quality crystal well protected against operating temperature variations is the key to good stability in a quartz crystal oscillator.

Modern AT-cut quartz resonators commonly show aging rates of less than 5 parts in 10^{10} a day. To avoid the degrading of this high stability, oscillator design must keep power dissipation within the crystal

constant and very low. Drive-level variations must be avoided by use of a good automatic gain control system. A typical value for the frequency change to be expected from a drive-level variation is about 10^{-9} per dB, at a microwatt level. Careful isolation from external loads is necessary.

Quartz crystal operating temperature must be maintained to a close tolerance since resonant frequency is temperature dependent. At Hewlett-Packard, temperature control is achieved by housing the crystal in an oven which maintains its temperature within close limits. For precision oscillators such as the HP Model 106A, B, a proportionally-controlled double oven houses not only the crystal but all critical frequency-determining elements. Proportional control is a refined technique that gives the utmost in temperature stability by continuously introducing heat in an amount continuously varied so as exactly to match heat loss. Continuous variation avoids temperature swings above and below the desired temperature (as in a thermostatically controlled system).

Oscillator elements directly associated with the crystal must exhibit good long term stability. Good stability often requires that such items as the series capacitors and the coarse tuning control be included in the temperature-controlled oven along with the crystal.

In the design of the basic oscillator, particular attention should be given to keeping the voltage coefficient of frequency low and supply voltages well regulated. Special care should be taken to minimize stray coupling and undesirable feedback which can introduce phase angle instabilities and can even cause changes in crystal power level.

3. TECHNIQUES FOR OBTAINING SPECTRAL PURITY

Even a very crude oscillator will have a reasonably good spectrum at the frequency of oscillation. The spectrum rapidly degrades with frequency multiplication, however, so that it is necessary to start out with an extremely good spectrum in order to have a good one result after the signal is multiplied into the microwave region.

If the frequency multipliers used are broadband, an expression for the spectrum of the multiplied signal may be given in terms of the ratio of total power in the observed sidebands to the carrier power. This ratio goes up as the square of the multiplication factor and may be written as follows:

$$\frac{P_N}{P_S} = n^2 \frac{P_{oN}}{P_{oS}}$$

where P_N = total sideband power in the multiplied frequency

P_S = carrier power

P_{ON} and P_{OS} = initial (before multiplication) sideband and signal powers

The above formula is valid only if the ratio P_N/P_S is very much smaller than unity.

As a numerical example, consider an oscillator at 1 MHz with noise phase modulation covering a rectangular band of 10 kHz. The sidebands will occupy a 20 kHz band centered about the oscillator frequency. Assume that the total sideband power is down 80 dB from the oscillator signal so that $P_{ON}/P_{OS} = 10^{-8}$.

By the time the signal is multiplied to 1 GHz, the ratio $P_N/P_S = 10^{-2}$, which is already a poor spectrum. Frequency multiplication to a higher frequency will result in a very rapid increase of P_N/P_S and spreading of the spectrum.

A simple way to improve this situation is to put the oscillator signal through a narrow bandpass filter before multiplication. Assume the filter is centered at 1 MHz and has a rectangular passband 20 Hz wide. Total sideband power in the output of the filter will now be 10^3 times smaller, so that $P_{ON}/P_{OS} = 10^{-11}$ and multiplication to 1 GHz will give $P_N/P_S = 10^{-5}$, which is still a fairly good spectrum. Therefore, in order to have a narrow spectrum with good signal-to-noise ratio after high-order frequency multiplication the initial signal-to-noise ratio must be very good and/or a narrow band filter must be used between the oscillator and the frequency multiplier.

Even though an oscillator may produce an output which has a very small noise sideband width, the bandwidths and noise levels of the amplifiers necessary for frequency multiplication contribute a significant amount of noise to the signal. This additive noise can be broken into two components, one an effective phase modulation of the signal and the other an effective amplitude modulation. The phase modulation can be treated as previously discussed and leads to the same degradation of the multiplied frequency spectrum. The effective amplitude modulation causes additional phase modulation, indistinguishable from true phase modulation. An oscillator which operates at a low power level in order to achieve good long-term stability will require a great amount of amplification in the multiplication process. It is apparent, therefore, that such oscillators will not in general, have good power spectra after being amplified and then multiplied to the microwave region, unless the frequency multiplier is preceded by a very narrow band filter.

It should be mentioned that coherent signal phase modulation, such as that due to the primary power supply, is handled in exactly the same manner as noise phase modulation described above, except that there are a discrete number of sidebands present instead of a continuous distribution. The sideband power-to-carrier power ratio can still be stated as in the equation given earlier.

4. QUARTZ OSCILLATORS

The Model 106A,B and 107AR,BR Quartz Oscillators are examples of the most advanced designs in precision frequency sources. Not only are signal stability and spectral purity outstanding, but these oscillators are rugged and reliable. The 107AR,BR is a hermetically sealed unit designed to pass MIL-type environmental specifications.

HP Quartz Oscillator Model 106A,B has extremely good long-term stability -- better than 5 parts in 10^{11} per day. Short term stability is also excellent -- 1.5 parts in 10^{11} for sample periods as short as 0.1 sec. Figure 5-1 shows the Model 106A,B. It should be emphasized that the 5 MHz output when multiplied to the microwave region has spectra only a few cycles wide.

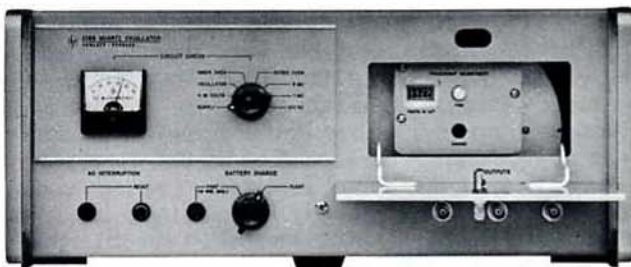

Figure 5-1. HP Quartz Oscillator Model 106A,B

In precision quartz oscillators, three main noise sources contribute to frequency fluctuations:*

- (1) thermal and shot noise in the oscillator
- (2) noise, additive in nature, arising in auxiliary circuits
- (3) fluctuations in the resonator frequency (leading to an apparent f^{-1} power spectral density)

Figure 5-2 shows a versatile system for evaluating frequency fluctuations in precision oscillators, here used to measure noise in a quartz crystal oscillator. In this system the two 106A,B oscillators are operated without offset from each other, an advantage since system noise can be evaluated by feeding both channels from one source. The Δf offset is obtained from the frequency synthesizer, acting as a local oscillator. In this way, fluctuations in the synthesizer cannot degrade the measurement any appreciable amount because the oscillator fluctuations have been multiplied by a large factor (~ 1840) before the comparison is made. The mixers used are of the low-noise type.

*Cutler, L.S., "Some Aspects of the Theory and Measurement of Frequency Fluctuations in Frequency Standards", presented at the Symposium on ... Short Term Frequency Stability, Goddard Space Flight Center, Greenbelt, Md., Nov. 1964.

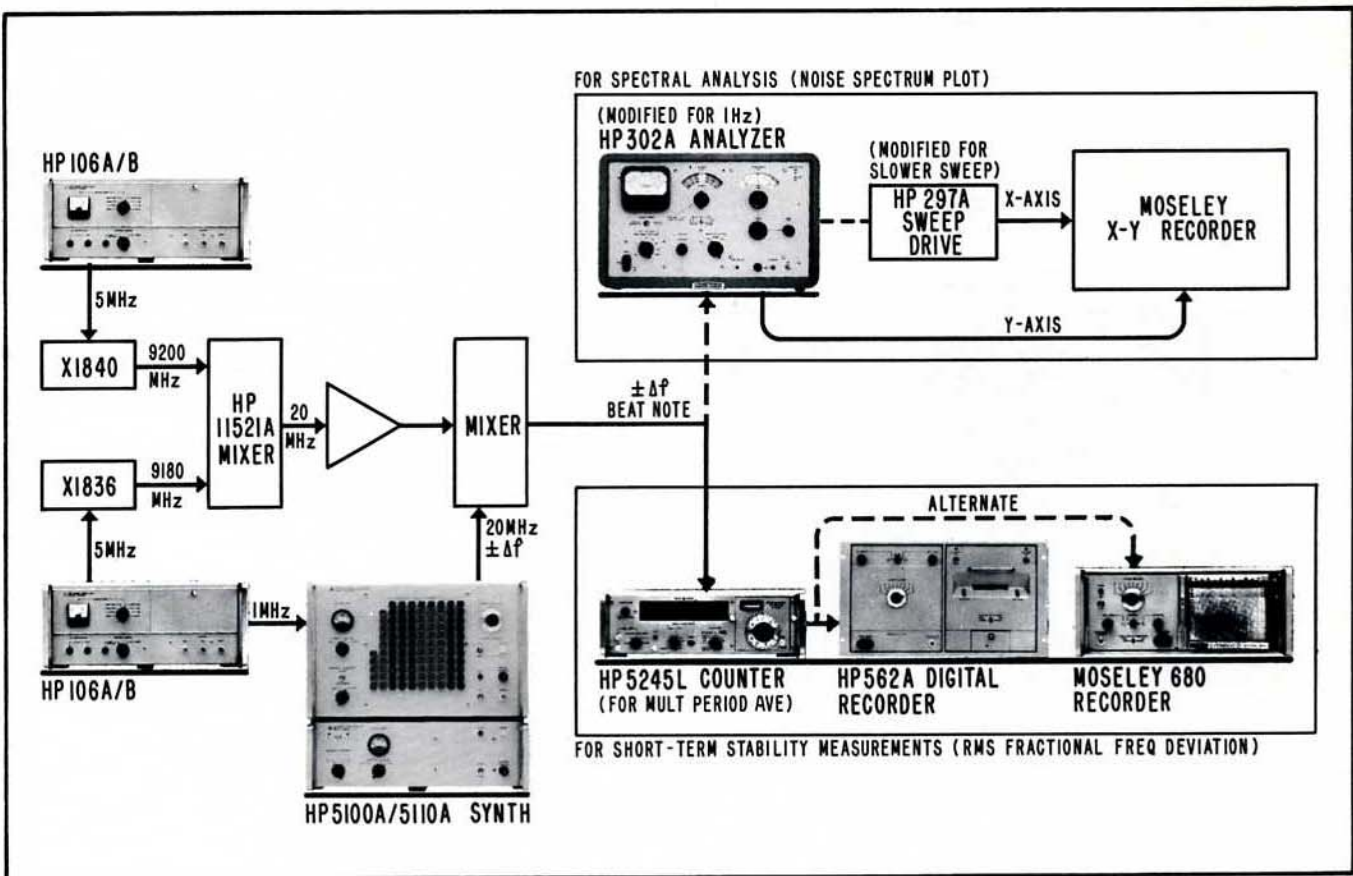

Figure 5-2. Versatile system for evaluating stability of quartz crystal oscillators

Addition of a counter and printer to the basic set-up makes it possible to evaluate the RMS fractional frequency deviation and the phase deviation as a function of time. The signal from the mixer, the Δf beat note, is counted (multiple period average) and the results printed. From these data it is possible to compute and plot RMS deviation. Figure 5-3 shows a plot of maximum RMS fractional frequency deviation and of maximum RMS phase deviation as a function of sample time for the 5-MHz output of a Model 106A,B Quartz Oscillator.

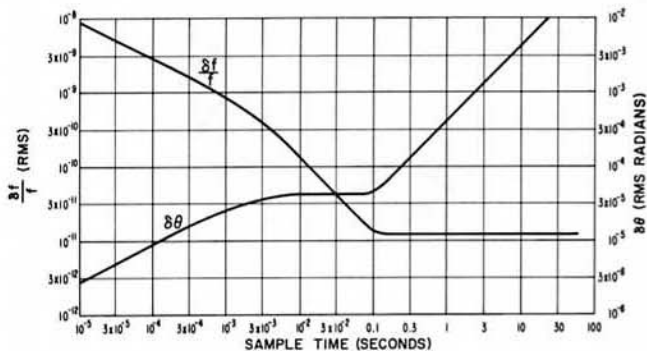

Figure 5-3. Maximum RMS fractional frequency deviation and maximum RMS phase deviation as a function of Sample Time for 5 MHz output of Model 106A,B Quartz Oscillators

Addition of a HP 302A Analyzer and a Moseley x-y Recorder makes possible a noise spectrum plot. Figure 5-4 shows a noise spectrum plot for the 106A,B.

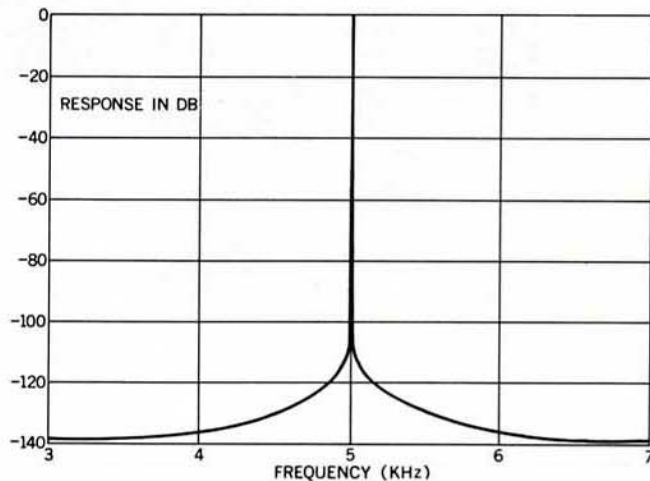

Figure 5-4. Spectrum of a 5 kHz Beat Note at 9.2 GHz (106A/B vs 106A/B)

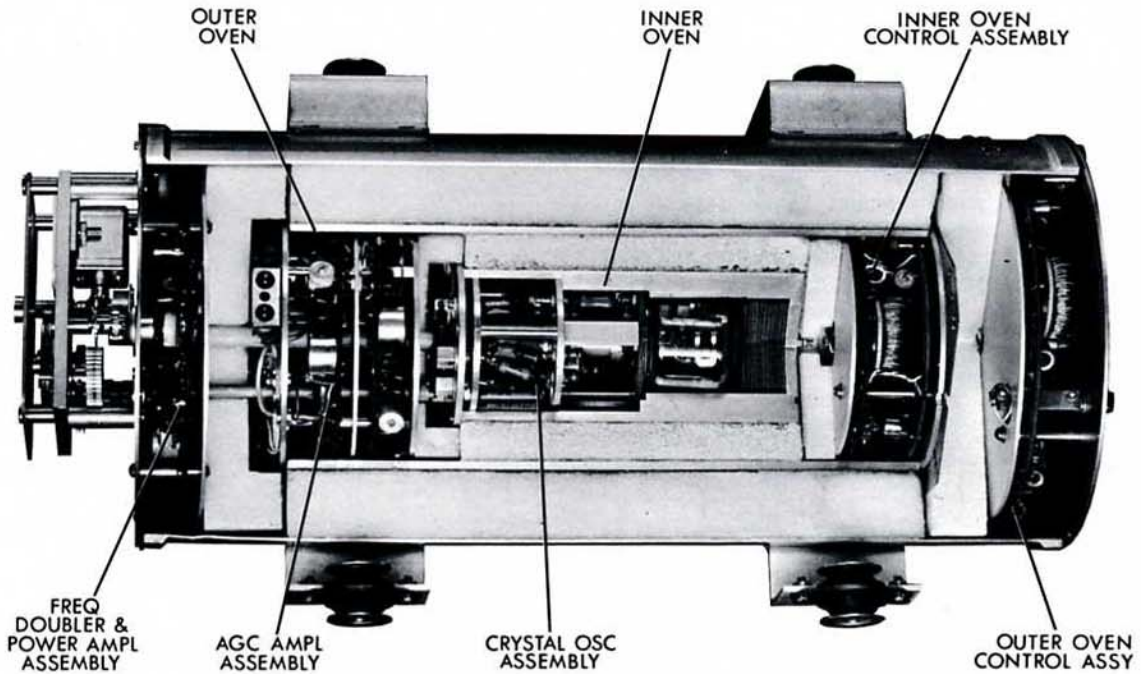
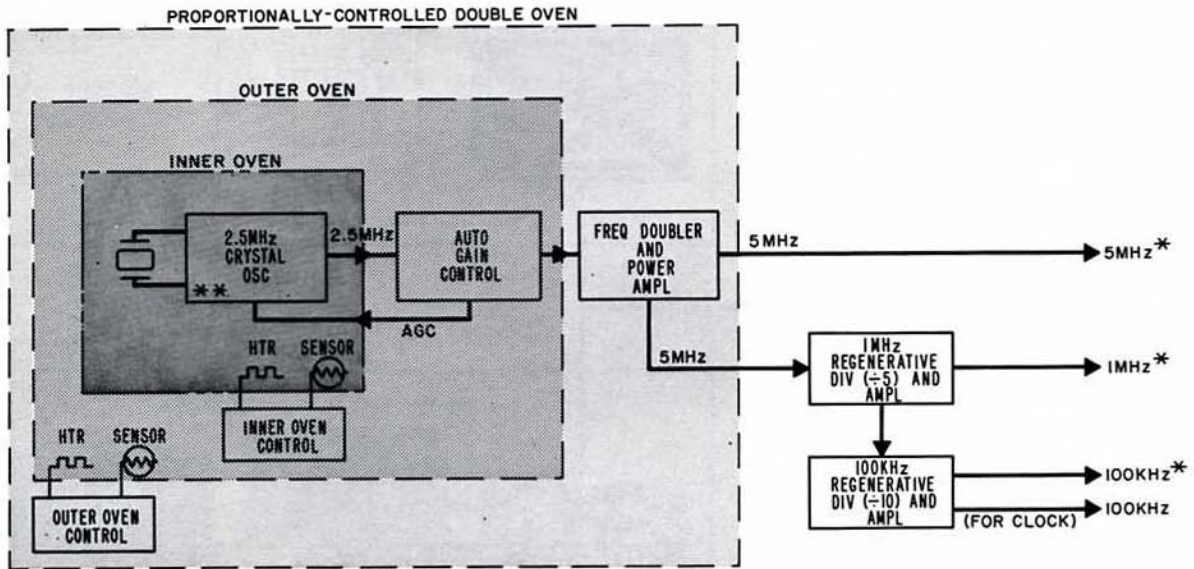

Figure 5-5. Schematic of 106A, B Oscillator and cutaway view of crystal oven assembly

Figure 5-5, a simplified block diagram of the Model 106A,B, shows how the 5 MHz, 1 MHz, and 100 kHz outputs are derived from the 2.5 MHz crystal oscillator. The 1 MHz and 100 kHz frequencies are derived by regenerative divider circuits which will not self-start after a primary power interruption. When the 106A,B is used to drive a clock such as the Model 115BR,CR, these outputs indicate by their presence that operation has been continuous (hence, time errors owing to interruptions are not being accumulated). Provision has been made for the control, over a small range, of output frequency.

The resulting degree of control makes these oscillators ideal for use in phase-locked systems.

Figure 5-5 also shows the proportionally-controlled double oven assembly. Contained within its three compartments are the 2.5 MHz quartz crystal oscillator, power amplifier, doubler, AGC circuits, and oven controllers. The factory-set operating temperature is selected for each unit so that the particular crystal is operating at its point of minimum temperature coefficient, that is, where the rate of change of frequency with small temperature fluctuations is a minimum.

APPENDIX

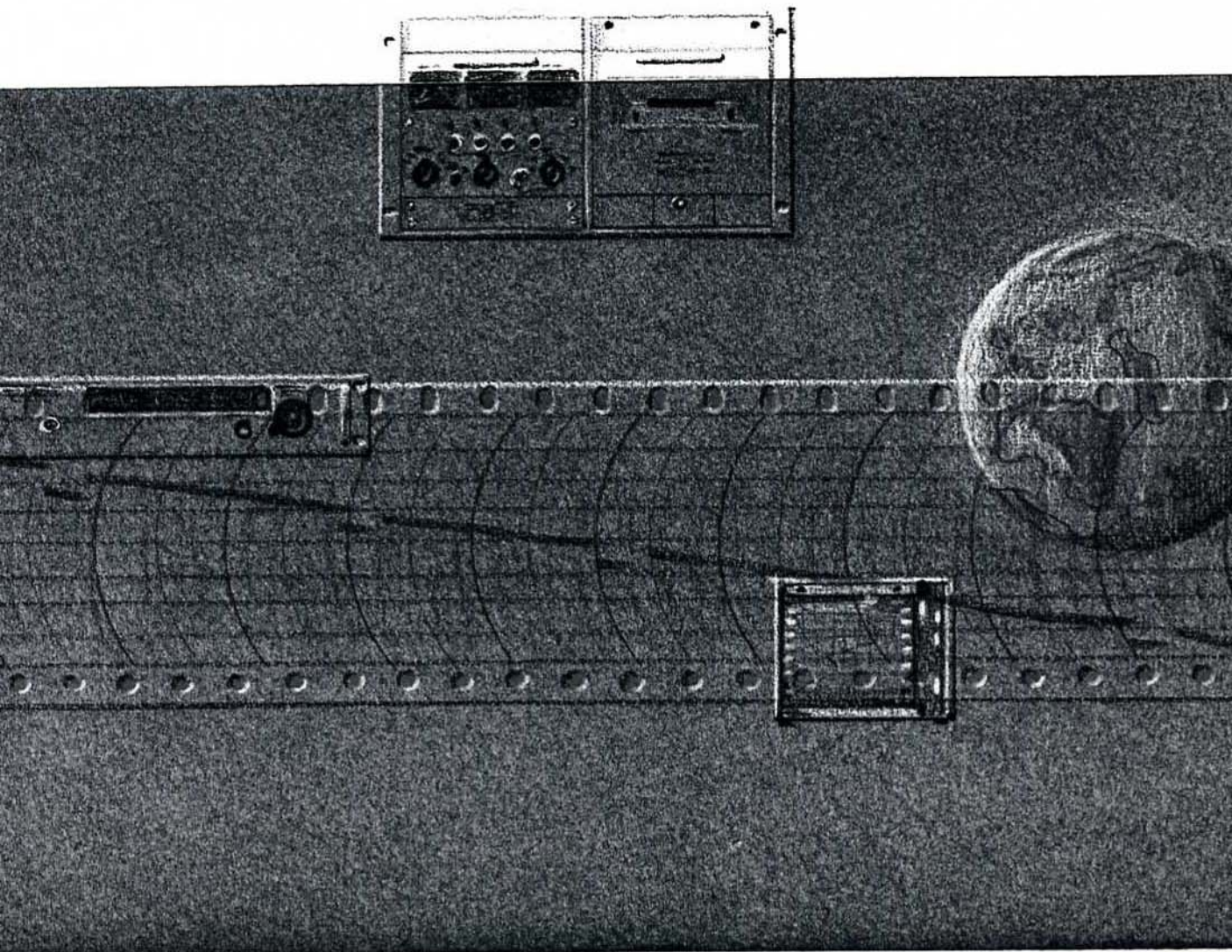

APPENDIX I

TIME

1. INTRODUCTION

A reference standard for a uniform time scale together with means to interpolate from it a small interval or an extended period is a goal which mankind has long pursued. Very recently, this goal seems to have been reached. Many nations have adopted a new standard which far surpasses in excellence any previously known -- the atomic second.

Earlier, a 1958 action based the time reference on the orbital motion of the earth about the sun, during the year 1900, establishing Ephemeris Time (ET). Ephemeris time is the culmination of age-old attempts to discover an invariant astronomical reference, first in the earth's rotation on its axis, and later in its motion about the sun. Ephemeris time appears to give the desired uniform reference. However, for reasons discussed later, it is neither easy to arrive at nor practical to compare against.

In 1964, therefore, the International Committee of Weights and Measures adopted as its tentative standard an atomic transition, specifically a hyperfine transition in the atom of cesium-133. A time interval of great uniformity based on this transition has been defined the atomic second. Careful measurements have related the atomic second to Ephemeris Time, and the atomic second is today's scientific time unit. (Measurements of great refinement made over many years will be needed to conclude definitely that atomic time and time based on astronomical observations are one and the same.)

This appendix to Application Note 52 discusses in some detail standards of time in the context of their historical development. The various time scales -- Apparent Solar Time, Mean Solar Time, Ephemeris Time, and others -- are described. Appendix II discusses time and frequency standards, and Appendix III discusses how United States time and frequency standards (and those of other nations as well) are made available through radio broadcasts. Appendix III includes a list of world-wide frequency and time standard broadcast stations.

2. APPARENT SOLAR TIME

For many centuries, the time reference used was the rotation of the earth about its axis with respect to the sun. A unit of time derived from observations of the apparent movement of the sun will obviously be a constant value only if the sun reappears over a fixed point of observation at uniform intervals. As man has increased the precision with which astronomical observations can be made it has been found that the rotation of the earth does not represent a uniform time scale. Even after all possible corrections are made for the known regular variations in the measurement conditions there still remain secular and irregular varia-

tions in the rotational speed of the earth which cause corresponding changes in this type of time scale.

An apparent solar day is dependent upon the position of the sun. Measurements made with a sun dial, for example, would give apparent time, since it would be in terms of the actual relative position of the sun. If the earth's orbit were a perfect circle and lay in the plane of the equator, the length of an apparent day would remain constant throughout the year.

Of course, the earth's orbit is not circular, it is elliptical, and the orbital plane does not coincide with the plane of the equator; it is at an angle of 23.5° to it. Because of this, apparent days vary in length. (The orbital speed of an object whose path describes an ellipse is constantly changing. The earth, as viewed from the sun, moves faster along that part of the orbit nearest the sun than at other times. Figure I-1 shows how this affects solar measurements.) The difference between apparent solar time and mean solar time is called the equation of time. It has its maximum value early in November when the difference is about 16 minutes.

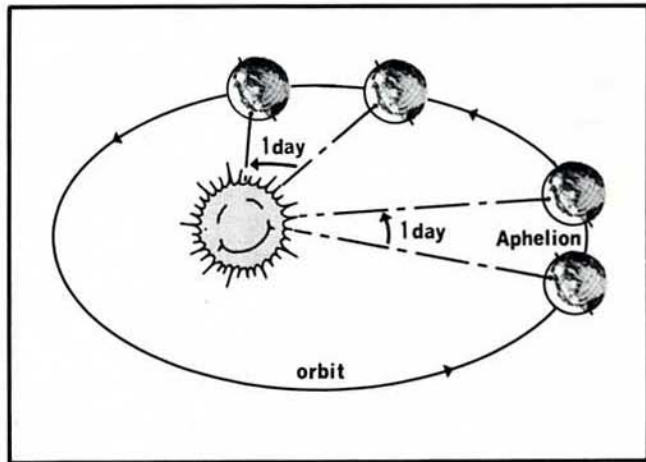

Figure I-1. Presentation of earth's orbital motion exaggerated to show varying effects on apparent solar day.

3. MEAN SOLAR TIME

Mean solar time is simply apparent time averaged to eliminate variations due to orbital eccentricity and the tilt of the earth's axis. A mean solar day is the average of all the apparent days in the year and a mean solar second is equal to a mean solar day divided by 86,400. As a fundamental unit of time the mean solar second is inadequate because it is still tied to the rotation of the earth which is now known to be non-uniform.

The solar (or tropical) year is a measure of the period of the earth's orbit as defined by observation of the time from vernal equinox to vernal equinox. Vernal equinox occurs about March 21 and is the time when the sun moves from the southern to the northern hemisphere in its apparent motion along the ecliptic; the ecliptic is the great circle formed by the intersection of the earth's orbital plane with the earth. It is along this great circle (intersecting the equator at about 23.5°) that the sun appears to move in a direction opposite to the earth's actual motion about the sun. One period of the ecliptic, then, is one solar year, as is shown in Figure I-2. A solar year is presently equal, in mean solar time, to 365 days, 5 hours, 48 minutes and 45.5 seconds, or in decimal form, 365.24219879 mean solar days.

Because the solar year by which we reckon time is 365 days plus a fraction, corrections must be made to our calendar at various times in order to make it correspond with the sun.

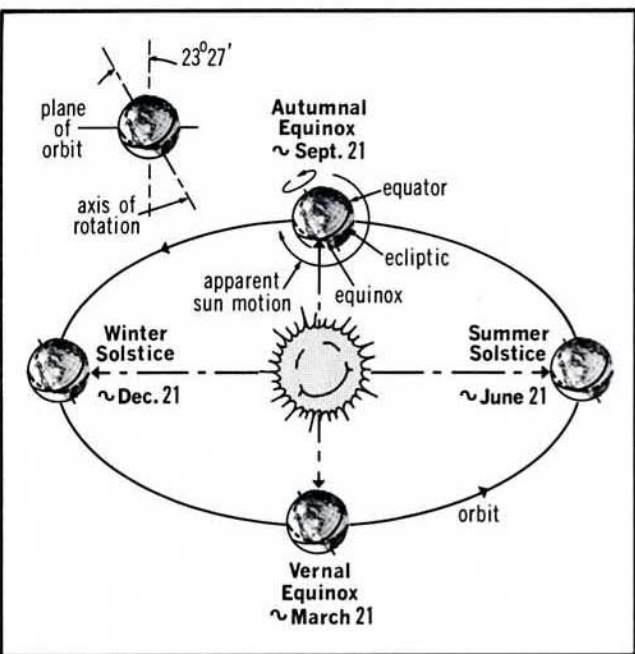

Figure I-2. Path of ecliptic traced by position of sun as earth moves about it.

4. UNIVERSAL TIME

As with mean solar time, Universal Time (UT) is based on the rotation of the earth about its axis; the units UT were chosen so that on the average, local noon would occur when the sun was on the local meridian. UT, thus defined, made the assumption that the rotation of the earth was constant and that it would, therefore, be a uniform time scale. It is now known that the rotation of the earth is subject to periodic, secular, and irregular variations, and universal time is naturally subject to these same variations. When uncorrected, the units of universal time are equivalent to the mean solar second, and are identified as a time scale by the designation UT_0 .

Correction to UT_0 has led to two subsequent universal time scales: UT_1 and UT_2 . UT_1 recognizes that the earth is subject to polar motion. The effect of this polar motion is to give an error to any uncorrected measurement of the earth's angular rotation. Figure I-3 illustrates this. UT_1 , then, is a time scale based on the true angular rotation of the earth about its axis.

The UT_2 time scale is UT_1 with an additional correction for seasonal variations in the rotation of the earth. These variations are apparently caused by seasonal displacement of matter over the earth's surface, such as changes in the amount of ice in the polar regions as the sun moves from the southern hemisphere to the northern and back again through the year. This cyclic redistribution of mass acts on the earth's rotation since it amounts to seasonal changes in its moment of inertia.

The time scale in widest use today is UT_2 . It represents the mean angular motion of the earth, freed of periodic variations, but still affected by irregular variation and secular variation. The units now provided by world-wide standard frequency and time stations, including WWV and WWVH (but not WWVB, which broadcasts the atomic time unit), are in substantial agreement with the current value of the unit of UT_2 .

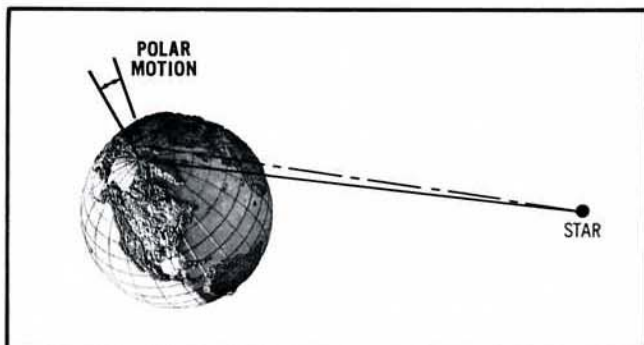

Figure I-3. Polar motion changes the apparent position of a fixed point of observation with respect to a distant celestial body.

5. SIDEREAL TIME

For some applications it is desirable to have a time scale that takes as its reference the relative position of the stars with respect to the rotation of the earth. Time defined in this manner is called Sidereal Time.

A sidereal day is strictly defined as the interval between two successive transits of the first point of Aries (a northern constellation) over the upper meridian of any place. In other words, it is the period of rotation of the earth obtained by observation of the stars and with reference to the stars. By way of comparison, a mean solar day is also obtained in practice from observations of the stars, but the measurement of rotation is referenced to the sun.

A sidereal day contains 24 sidereal hours, each having 60 sidereal minutes of 60 sidereal seconds. In mean

solar time a sidereal day is about 23 hours, 56 minutes, and 4.09 seconds. The time difference in the two days is due to the earth's motion about the sun and the influence of this motion on the apparent position of the sun among the stars. What happens is that during the course of day, orbital motion causes the sun to appear to move a little to the east among the stars. Even if the earth did not rotate, the sun would appear to move eastward completely around the earth during one period of the earth's orbit. The effect of this apparent motion is that the day referenced to the sun is about 4 minutes longer than the day referenced to the stars. Figure I-4 shows these relationships. For the same reason a solar year will contain 366.24+ sidereal days, or one more than the number of mean solar days.

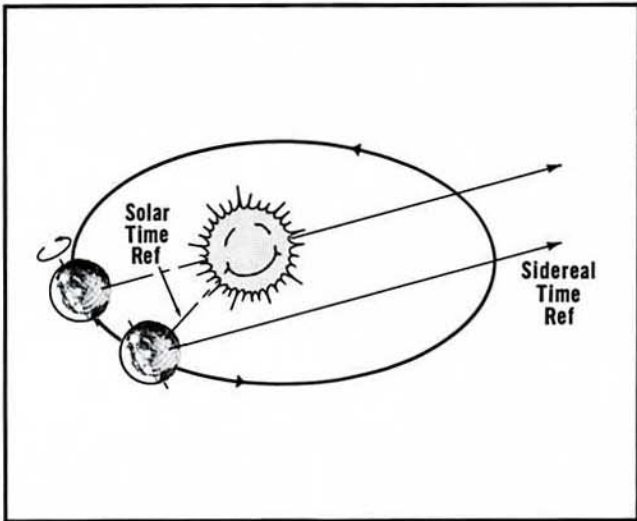

Figure I-4. Since the length of the solar day is referenced to the sun, orbital motion lengthens the solar day over what it would be if the earth were fixed in position. Sidereal time is referenced to distant stars; orbital motion is of no consequence.

A sidereal year is a measure of the exact period of revolution of the earth around the sun. It is the true time interval required for the earth to move from a position of alignment with a given star as seen from the sun to the same position of alignment again. This is illustrated in Figure I-5.

As compared to the length of the solar, or tropical, year of 365.24219879 mean solar days, the sidereal year is the longer by about 20 minutes. The reason for this is that the solar year is based not on the period of the earth with respect to a fixed point on the orbit, but on the vernal equinox. Since the equinoxes are subject to precession, the point at which the sun appears to move from the southern to the northern hemisphere does not occur at precisely the same point on the orbital path from year to year. Therefore it follows that the solar year will differ from the sidereal year. Since the precession is westward, equinox occurs sooner than it would if there were no motion of precession.

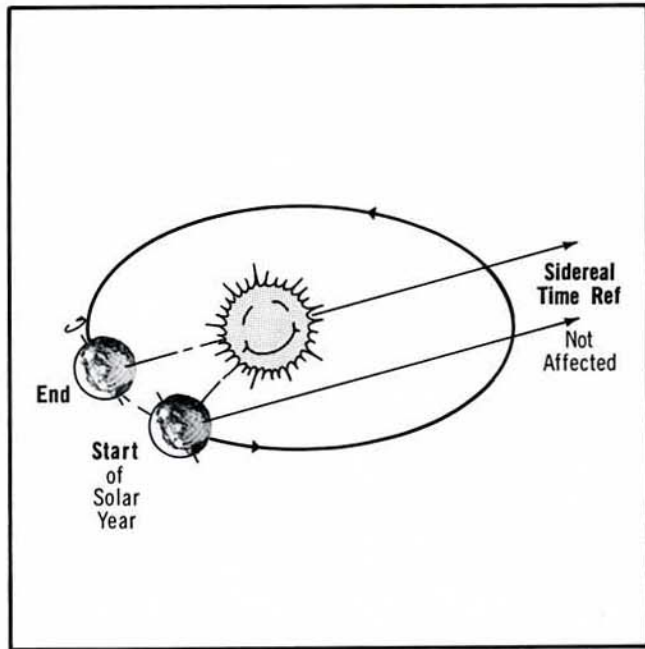

Figure I-5. Precession of the equinoxes causes the solar year to be about 20 minutes shorter than the sidereal year.

Precession of the equinoxes is due to change in the direction of the earth's axis of rotation. This movement is similar in nature to the precession of a spinning top when subjected to a lateral force. In the case of the earth, the force is the gravitational pull exerted by the sun and the moon upon the bulge in the earth about the equator. As shown in Figure I-6, this force causes the poles to move in a circular, but wavy, path.

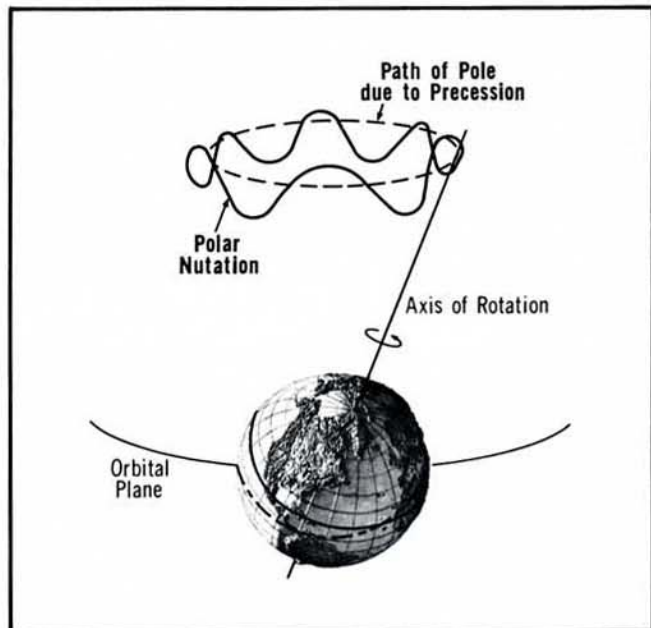

Figure I-6. Nutation superimposes a seasonal wavy motion on the circular path of precession.

path. The circular motion is precession; the superimposed wavy motion is called nutation. Nutation results from the fact that the forces causing precession are not uniform (they depend on the relative positions of the sun and moon to the earth). For example, when the sun is directly over the equator it can cause no precession, since under this condition, the sun can exert no net force outside the plane of orbit. Precession of the equinoxes takes place at a very slow rate having a period of about 25,000 years, and a complete period of rotation is called the platonian or great year.

6. MEAN SIDEREAL TIME

Mean sidereal time differs from apparent sidereal time because of the nodding or nutation of the earth's axis. This difference has a maximum value of only about a second or so. Sidereal time is not influenced by the orbital motion of the earth, since the stars that are observed are so very distant that their apparent positions do not vary as the earth moves about the sun.

Because the difference between mean and apparent sidereal time is so small, sidereal time is the scale generally used by astronomers. Also, of course, since sidereal time is based on the true rotation of the earth referenced to the stars, it provides a straightforward unit by which to fix the position of stars for astronomical observations. A clock keeping time in sidereal units must, in the course of a tropical year, indicate the passage of one day more than it would indicate in mean solar units.

7. EPHEMERIS TIME

As discussed earlier with regard to Solar Time, the rotation of the earth on its axis does not take place at a constant rate and, as a result, time units derived from it do not provide an invariable standard. Even when all possible corrections have been made, an insurmountable uncertainty still remains since the rate of rotation of the earth fluctuates unpredictably. (These irregular changes are thought to be due to readjustments in the interior of the globe that produce small changes in diameter.) Furthermore, the earth is known to be slowing in its angular rate in a secular manner due to tidal friction. This change amounts to about a millisecond per century and, since it is secular, it does not lend itself to correction in uniform time units.

The search for a uniform time unit has led astronomers to define an additional kind of time called Ephemeris Time (ET). Ephemeris time is astronomical time based on the motion of the earth about the sun. It is obtained in practice from observations of the motion of the moon about the earth. In October, 1956, the International Committee of Weights and Measures defined the second of ET as the fraction $1/31,556,925.9747$ of the tropical year for January 0, 1900 at 12 hours ephemeris time. The tropical year for the moment of 12 hours, January 0, 1900, is the length the tropical year would be if the sun continued at its apparent instantaneous rate, corrected for orbital eccentricity and nutation of the earth's axis.

The second of ET, thus defined, appears to fulfill the requirements for an invariable unit of time (Universal time is the time by which we live, however, and the broadcast frequencies of most standard stations are set so as to establish a unit in substantial agreement with the current value of UT_2).

Tables published by Simon Newcomb at the end of the 19th century gave the position of the sun for regular intervals. These intervals, until recently, were thought to be in terms of UT. It is now recognized that ET is the actual scale and the tables may therefore be used as the basis for measuring ET. In other words, the ephemeris time scale places celestial bodies in repeatable astronomical relationships to each other year after year.

As mentioned, ET is obtained in practice by observing the motion of the moon about the earth. Lunar position tables have been constructed in conformity with the internationally adopted solar ephemeris and permit the determination of ET directly from the observation of the moon.

Because of the difficulty of making precise measurements of the position of the moon, except by observations made for a fairly long time, the delay in the determination of ET to any useful degree of accuracy is on the order of several years.

8. ATOMIC TIME

Given an atomic frequency standard (the cesium beam) and a unit of time interval based upon it (the atomic second), an "atomic time" scale (such as NBS-A) can be derived.

The exact definition of the atomic second, now the United States standard of time interval, is given in Appendix II together with an explanation of its relationship to the ephemeris second.

It had long been the desire of physicists to find some way to derive from the natural frequencies of atoms and molecules a direct measure of rate and of time interval. With the development and refinement of atomic resonators, it has become possible to control thereby the frequency of an oscillator, hence, by means of frequency conversion, to operate clocks.

An atomic clock with a precision exceeding 1 microsec per day has been placed in operation at Boulder, Colorado by the U. S. National Bureau of Standards.* NBS maintains an atomic time scale designated NBS-A with this clock. NBS-A is based upon five oscillators (presently there are four quartz oscillators and one rubidium gas cell) which are frequency-compared daily against the USFS (described in Appendix II). The cycles are counted (an accumulated total is kept) and a suitable weighted average is taken.

*Barnes and Mockler, "The NBS Time Scale and Its Relation to Other Time Scales, Progress in Radio Science, 1960-63, Vol. 1, p. 41, Elsevier, Amsterdam, 1965.

The U. S. Naval Observatory maintains an atomic time system designated A. 1, based upon a weighted average of cesium beam standards operated at various locations in Europe and North America.

The Observatory of Neuchatel, Switzerland, maintains an atomic time scale designated TA₁. A comparison of TA₁ and NBS-A reported in the IEEE Proceedings* shows a divergence of only about 1 part in 10¹¹, stated to illustrate the practicality of keeping time by quantum electronics techniques.

9. U.S. STANDARD TIME**

U. S. Standard Time differs from UT₂ by an integral number of hours. It is kept by the U.S. Naval Observatory's master clock, which consists of an atomic resonator, a quartz crystal oscillator, and a clock movement.

The atomic resonator monitors the frequency of a 2.5 MHz quartz oscillator, kept offset from the atomic frequency to yield UT₂. Oscillator output, divided down to 100,000 Hz, is fed to a Hewlett-Packard clock consisting of a divider, clock movement, and seconds pulser. The 1000 Hz output drives a synchronous motor geared to indicate hours, minutes, and seconds. The seconds pulses serve as the precise reference.

*Bonanomi, Newman, Barnes and Atkinson, "A Comparison of the TA₁ and the NBS-A Atomic Time Scales", *Proc. IEEE* 52, 4 (April 1964).

**Based on an Article by W. Markowitz, "Time Measurement Techniques in the Microsecond Region", *The Engineer's Digest*, p. 9, July-August 1962.

The master clock is compared with observations for Universal Time made by the U. S. Naval Observatory on each clear night with photographic zenith tubes (a PZT is a specialized telescope fitted for extremely accurate photographic observations of stars that transit near the zenith). The U.S. Naval Observatory is responsible for maintaining the reference for time interval and epoch time for the Dept. of Defense (DoD Directive 5160.51, 1 Feb. 1965).

10. TIME ZONES

The continental U. S. is divided into four standard time zones, with the time in each an integral number of hours different from (earlier than) Greenwich Mean Time, which is the same as Universal Time. They are: Eastern, 5 hrs. earlier; Central, 6 hrs; Mountain, 7 hrs; and Pacific, 8 hrs.

World time zones number 24 and are based upon longitude. By international agreement, the central cross hair of an historic instrument called the Airy Transit Circle, in Greenwich, England, marks the prime meridian at 0° longitude.

The prime meridian is an imaginary great circle, crossing both geographic poles. Standard time zones are established at intervals of 15° of longitude east and west of the prime meridian. Time zones in the continental United States are roughly centered along the meridians of 75°, 90°, 105°, and 120°. The exact boundaries of the time zones are modified by political and geographic considerations, but they are approximately a belt 7-1/2° on either side of the zone reference meridian.

APPENDIX II

NATIONAL STANDARDS OF TIME AND FREQUENCY

A critical requirement for useful modern standards is that they be rigorously consistent along the entire chain of measurements tracing back to international prototype standards representing the fundamental units of mass, length, and time.

To provide the nation with the central basis for a self-consistent and uniform system of physical measurement is the primary mission of the U.S. National Bureau of Standards (NBS).

Boulder, Colorado is the NBS center for precision measurements of frequency and time.

1. NBS BOULDER

At the NBS Electronic Calibration Center, which occupies one wing of the Radio Standards Laboratory at Boulder, NBS makes available to government, industry, and the military services access to the nation's primary electronic standards. The Radio Standards Laboratory is part of the Institute for Basic Standards, one of the three Institutes which presently constitute the National Bureau of Standards.

NBS shifted its radio standards work to Boulder in 1954. Earlier, radio standards were the responsibility of the Central Radio Propagation Laboratory, originally located in Washington D. C. Radio standards work was begun in 1911.

The Radio Standards Laboratory maintains the U.S. Frequency Standard at Boulder and disseminates it via low frequency and very low frequency broadcasts from nearby Ft. Collins (WWVB and WWVL) and from the older high frequency stations (WWV and WWVH).

2. UNITED STATES FREQUENCY STANDARD

The U.S. Frequency Standard has been maintained since 1920. Improvement in its precision has been steady and took a sharp upturn in 1960 when a cesium beam apparatus became the device which provides the Standard.

NBS states the present standard to be accurate to five parts in 10^{12} (3σ limits), an accuracy higher than that achieved in the measurement of any other quantity. One to two parts in 10^{13} are attainable for measurement times of about one hour. NBS has work under way on a standard to exceed even this high accuracy.

Figure II-1, reproduced from a publication of NBS*, shows improvements since 1920 in the precision of the U.S. Frequency Standard and its dissemination. The level of accuracy required by different users is indicated.

*National Bureau of Standards, "Precision of the U.S. Frequency Standard", NBS Technical News Bulletin 48:2, p. 31 (Feb. 64).

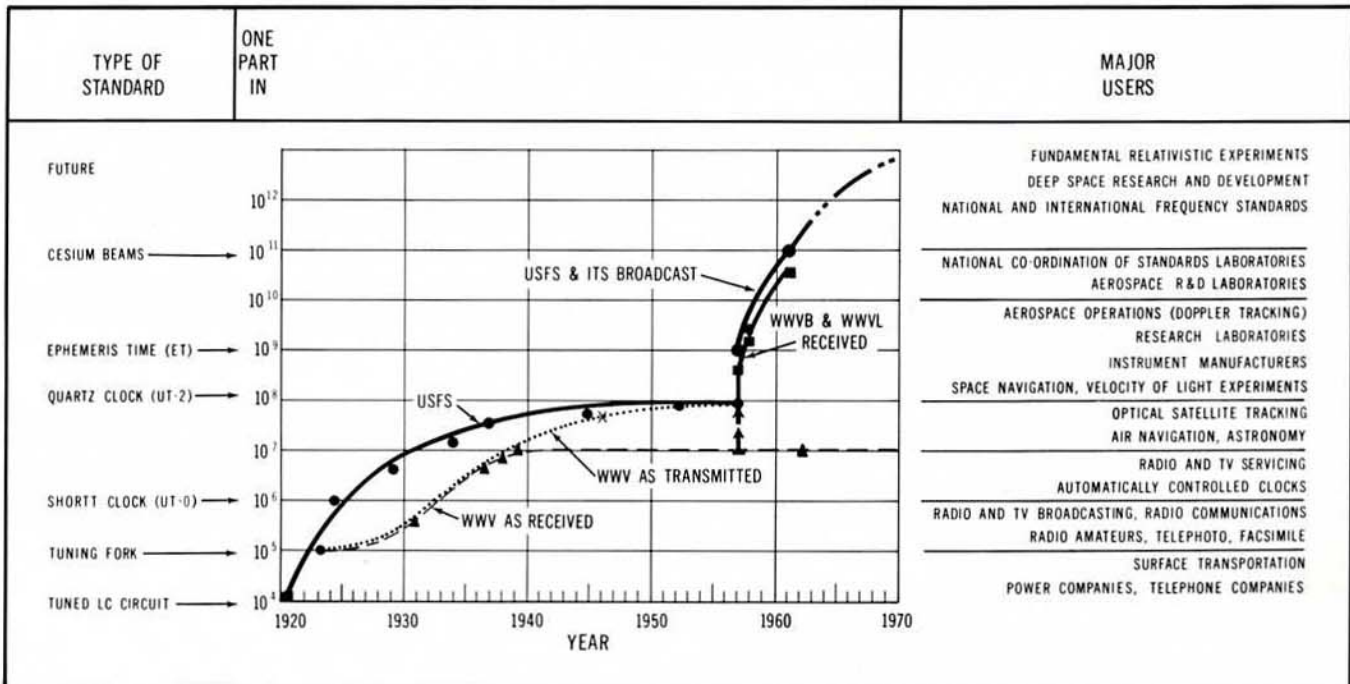

Figure II-1. Improvements in the precision of the U.S. Frequency Standard (USFS) and its dissemination.

3. UNITED STATES TIME UNIT

Effective January 1, 1965, NBS low-frequency station WWVB began to broadcast the international unit of time based upon the atomic standard.

The atomic definition of the second was authorized in October 1964 by the Twelfth General Conference of Weights and Measures, meeting in Paris. The Conference action based the definition on a transition in the cesium atom for the present, in anticipation that an even more exact definition may be possible in the future.

The international second has been redefined before, always with the realization of increased exactness. In 1956, the second called the ephemeris second was defined as a certain fraction of the time taken by the earth to orbit the sun during the tropical year 1900. Earlier than 1956, the second was defined as a fraction of the time required for an average rotation of the earth on its axis with respect to the sun.

The atomic definition realizes an accuracy much greater than that achieved by astronomical observations. It results in a time base more uniform and much more convenient. Now determinations can be made in a few minutes to greater accuracy than was possible before in measurements that took many years.

The exact wording of the action of the Twelfth General Conference is: "The standard to be employed is the transition between two hyperfine levels $F = 4, m_F = 0$ and $F = 3, m_F = 0$ of the fundamental state $^2S_{1/2}$ of the atom of cesium-133 undisturbed by external fields and the value 9 192 631 770 hertz is assigned."

4. AGREEMENT WITH EPHEMERIS TIME

The new definition of the second is in as close agreement as is experimentally possible with the earlier (Ephemeris) definition.

It is possible that Ephemeris Time and time based on the cesium transition may not have the same rate. Further experiments of great refinement will be required to decide this question. The U. S. Naval Research Laboratory and the U. S. Naval Observatory have a continuing program for checking the cesium beam standard against astronomical observations. Over the course of a number of years an improvement will result in the precision with which the value of the two time measurements can be compared.

The U. K. National Physical Laboratory, Teddington, and the U. S. Naval Observatory, Washington, D. C., cooperated in a joint program to determine the frequency of cesium-133 in terms of the ephemeris second as used in its definition.*

5. NBS BROADCASTS

The NBS Radio Standards Laboratory disseminates its standards by broadcasts from four radio stations (see

*Markowitz, Hall, Essen, and Parry, "Frequency of Cesium in Terms of Ephemeris Time", *Physical Review Letters* 1, 3, August 1, 1958.

Appendix III). WWVB (low frequency, 60 kHz) and WWVL (very low frequency, 20 kHz) at Ft. Collins are phase-locked via HF transmission to the U. S. Time Standard at Boulder. The older, high frequency stations are WWV at Beltsville, Maryland, and WWVH, at Maui, Hawaii (NBS plans to move WWV to Ft. Collins by 1967).

The standard carrier broadcast from WWVB is maintained without offset with respect to the U. S. Frequency Standard within a tolerance limit of $\pm 2 \times 10^{-11}$. Other NBS broadcasts do have an offset, that is, the broadcast frequency is based on the value of the Standard, some multiple, or some sub-multiple of it, minus a fixed amount of offset.

Need for the offset arises from variation inherent to the time scale ordinarily used in daily life, which is based upon the rotation of the earth and intervals derived from that rotation: hours, days, and years. This scale is quite variable in comparison to that based on the U. S. Frequency Standard. Time scales whose units differ from those of the Standard are represented by oscillations offset from the Standard by an amount proportional to the difference in the units employed.

6. TIME SIGNAL OFFSETS FOR WWV AND WWVH

Time signals from WWVB are exactly one second (international atomic interval) apart. Those from WWV and WWVH are slightly greater than one second apart, the fractional difference for 1965 being 150 parts in 10^{10} . By use of this small adjustment, these time signals are kept more in step with UT_2 . Related as it is to the earth's rotation, UT_2 proceeds at a rate slightly slower than one based on the international atomic second.

The amount of the frequency offset is fixed by the Bureau International de l'Heure. For 1965 the offset is -150×10^{-10} , and for 1966 it is -300×10^{-10} . The offset is made in accordance with an international agreement whereby time signals from cooperating stations are kept within about 100 milliseconds of UT_2 .

WWV, WWVH, and WWVL are offset by this amount from the standard frequencies controlled by the U. S. Frequency Standard.

It has been recommended that future consideration be given to avoiding the complications of offsets by seeking international agreement to have only the definitive unit of time made available via broadcasts of time signal and standard frequencies.** Users who require Universal Time would then apply a published table of differences to arrive at UT_2 .

**L. Essen, "Atomic Beam Frequency Standards", *Progress in Radio Science 1960-63*, Vol. 1 (Proc. URSI, Tokyo, September 1963) p. 11, Elsevier, New York, 1965.

APPENDIX III

STANDARD FREQUENCY AND TIME SIGNAL BROADCASTS

1. INTRODUCTION

High frequency and LF/VLF radio broadcasts disseminate standard frequency and time signals around the world. This Appendix to AN-52 lists (in Part 4) important characteristics of many of these stations in two tables which present separately the high frequency stations and the LF/VLF stations. Details of the standards services of NBS are first presented, followed by those of the U. S. Navy.

The International Radio Consultative Committee (CCIR), which met in plenary session in Los Angeles in 1959 and in Geneva in 1963, has working committees that examine on a continuing basis such matters as standardized presentation of radio time signals, intercontinental frequency synchronization, interferences with standard frequency and time signal emissions, and in general, means for improving standards services worldwide.

CCIR session records contain a complete description of worldwide frequency and time signal stations,* including detailed daily and hourly schedules for many.

One example of international agreement in the area of frequency and time signals is that of the adjustments made periodically whereby time broadcasts are synchronized to about one millisecond and kept within about 100 milliseconds of UT₂. Participating countries include Argentina, Australia, Canada, Czechoslovakia, France, Italy, Japan, South Africa, Switzerland, United Kingdom, and the United States. The Bureau International de l'Heure makes periodic announcements concerning offsets and adjustments to be made by the coordinated stations.

2. NBS FREQUENCY AND TIME SERVICES

The U. S. National Bureau of Standards operates four standard frequency stations. WWV at Greenbelt, Maryland, and WWVH at Maui, Hawaii, broadcast at high frequencies. WWVB and WWVL at Ft. Collins, Colorado, broadcast at 60 kHz and at 20 kHz respectively.

Complete information regarding the NBS services is contained in an NBS publication which is revised annually:

Standard Frequency and Time Services of the National Bureau of Standards, Miscellaneous Publication 236. For sale by the Sup't of Documents, U. S. Government Printing Office, Washington, D. C. 20402. Price 15 cents.

*"Documents of the Xth Plenary Assembly, Geneva 1963", Volume III - "Standard Frequencies and Time-Signals", Int. Telecommunication Union, Geneva, page 200 ff.

For convenience, certain information adapted from the 1965 edition regarding present schedules, time pulses, and time code transmissions is presented in this Appendix to AN-52.

NBS publication No. 236 states that inquiries concerning NBS broadcast services may be addressed to the Engineer in Charge at a particular station. Users of NBS stations WWVB and WWVL should request that their installation be placed on the NBS mailing list to receive advance notices of changes, and other helpful information. Write:

National Bureau of Standards
Frequency-Time Broadcast Services 251.02
Boulder, Colorado 80301

Notices regarding NBS frequency and time services have regularly appeared in the NBS publication "NBS Technical News Bulletin" and in "Proceedings of the IEEE" under the heading, "Standard Frequency and Time Notices."

A. SCHEDULE OF BROADCASTS.

The four NBS stations are listed along with other world-wide standard stations in Tables 1 and 2. Figure III-1 is a revision of the detailed hourly broadcast schedules as shown in the NBS Publication 236, 1965 edition, to which reference has been made.

B. WWV AND WWVH TIME PULSES AND CODING.

Figure III-2 shows seconds pulses broadcast on high frequency stations WWV and WWVH, and Figure III-3 shows time code transmissions from WWV.

The WWV time code transmission is made for one minute out of five, ten times per hour, and is produced at a 100 pps rate carried on 1000 Hz modulation (see NBS Publication 236 for full details).

Receiving stations which are nearly equidistant from WWV and WWVH may experience tick interference. This interference can be reduced by using a directional antenna which favors the desired signal or by scheduling measurements for a time when only one of the two stations is transmitting (consult the schedule in Figure III-1 to determine these times).

C. WWVB TIME PULSES AND CODING.

For WWVB, time code information is presented by means of a level-shift carrier code. This binary-coded-decimal (BCD) transmission is synchronized with the 60 kHz carrier.

The time signals are indicated by 60 drops in power level per minute, one marking each second. The amount of the drop is 10 dB. The length of time before power is restored indicates more detailed information in accordance with the following code:



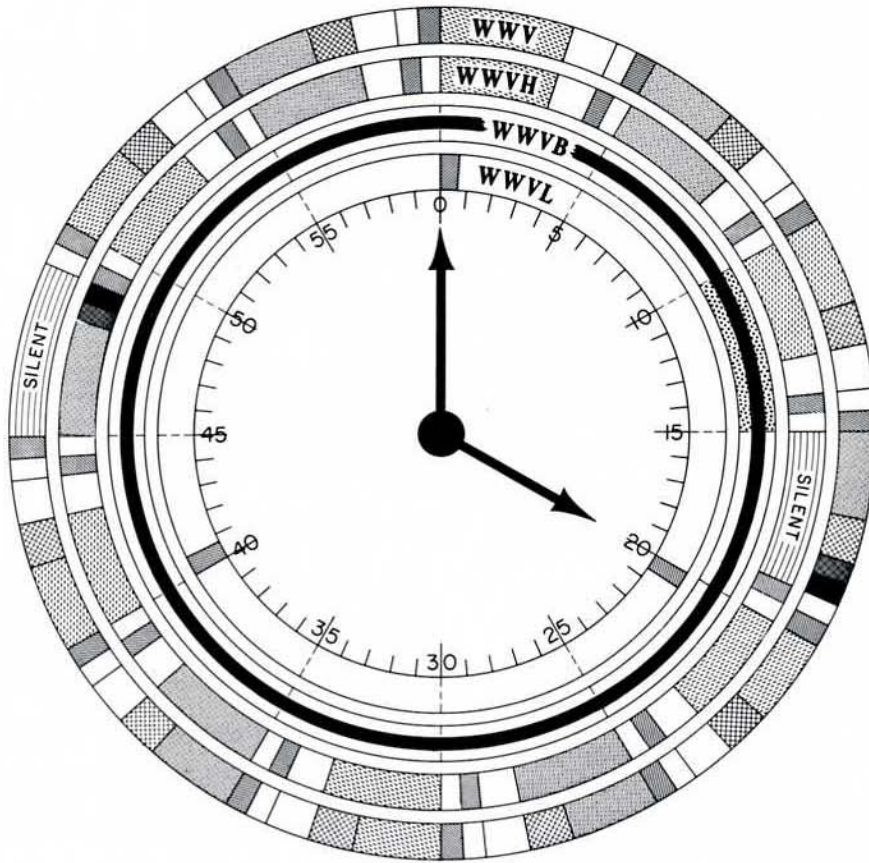





THE HOURLY BROADCAST SCHEDULES OF WWV, WWVH, WWVB AND WWVL



SECONDS PULSES - WWV, WWVH - CONTINUOUS EXCEPT FOR 59th SECOND OF EACH MINUTE AND DURING SILENT PERIODS

WWVB - SPECIAL TIME CODE

WWVL - NONE

 STATION ANNOUNCEMENT	 100 PPS 1000 Hz MODULATION WWV TIMING CODE
<u>WWV</u> - MORSE CODE - CALL LETTERS, UNIVERSAL TIME, PROPAGATION FORECAST	 TONE MODULATION 600 Hz
VOICE - EASTERN STANDARD TIME	 TONE MODULATION 440 Hz
MORSE CODE - FREQUENCY OFFSET (ON THE HOUR ONLY)	 GEOALERTS
<u>WWVH</u> - MORSE CODE - CALL LETTERS, UNIVERSAL TIME, VOICE - HAWAIIAN STANDARD TIME	 IDENTIFICATION PHASE SHIFT
MORSE CODE - FREQUENCY OFFSET (ON THE HOUR ONLY)	 UT-2 TIME CORRECTION
<u>WWVL</u> - MORSE CODE - CALL LETTERS, FREQUENCY OFFSET	 SPECIAL TIME CODE

REVISED JULY 1965

Figure III-1. The Hourly Broadcast Schedules of WWV, WWVH, WWVB, and WWVL

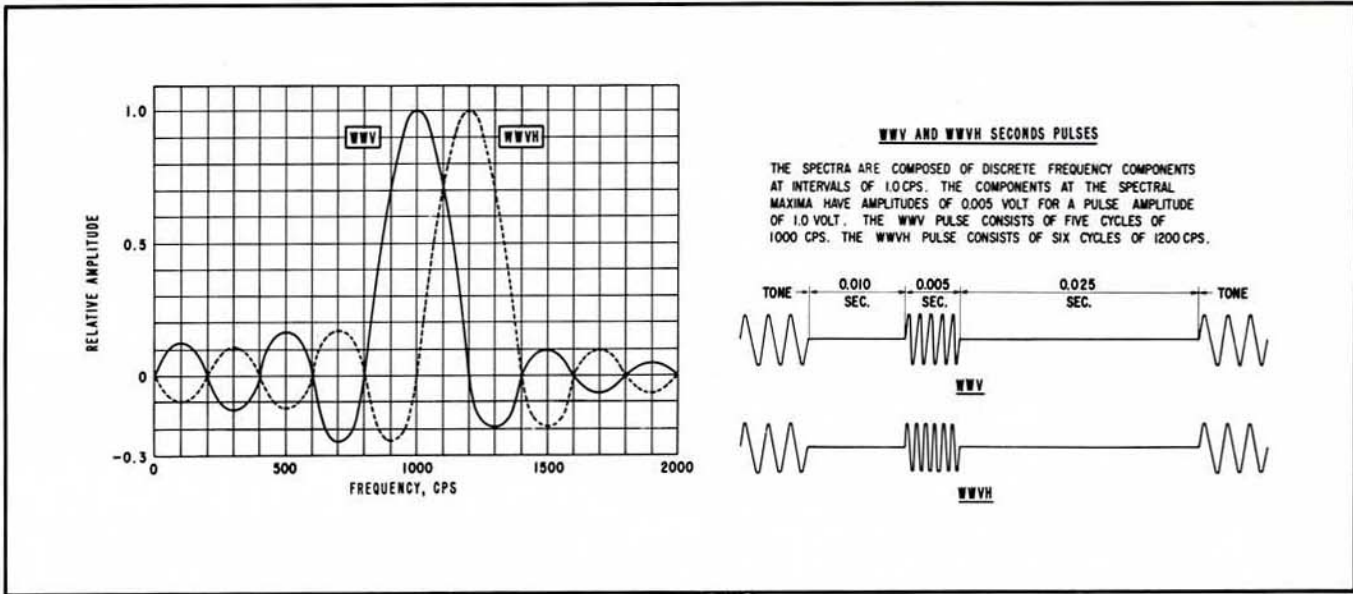

Figure III-2. Sample Characteristics of Time Pulses Broadcast from NBS Stations WWV and WWVH.

- (1) For a binary code zero, 0.2 sec later
- (2) For a binary code one, 0.5 sec later
- (3) For a marker pulse, which designates each 10 sec and the minute reference, 0.8 sec later.

Figure III-4 shows the NBS code, with the zero, one, and marker pulse encircled.

The minute reference marker occurs in the first second of each minute. The 10-sec reference markers occur each ten seconds including the 60th. Thus, a double marker pulse starts each minute and gives an easily identified origin point.

The BCD code presents time-of-year information each minute: the minute, the hour, the day of the year, and the millisecond difference between the time of broadcast signal and the best approximation to UT_2 .

An example of a typical minute is shown in Figure III-4. We note that the first bit of information presented after time zero is the minute reference marker, a 10dB reduction 0.8 sec in length. Proceeding from left to right (advancing in time) we find areas displaying minutes, hours, day-of-the-year, and the correction to arrive at UT_2 . Areas are separated by one of the 10-sec markers (shaded for emphasis) or an uncoded

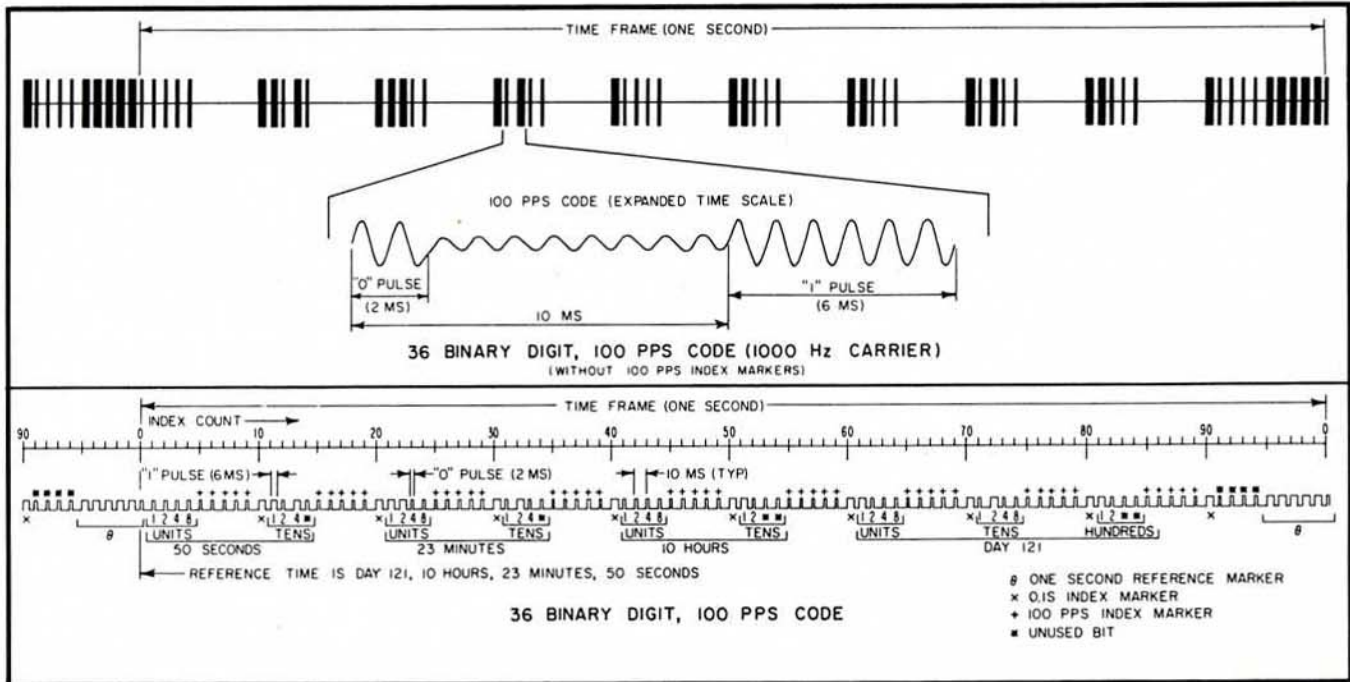

Figure III-3. Chart of Time Code Transmissions from NBS Station WWV.

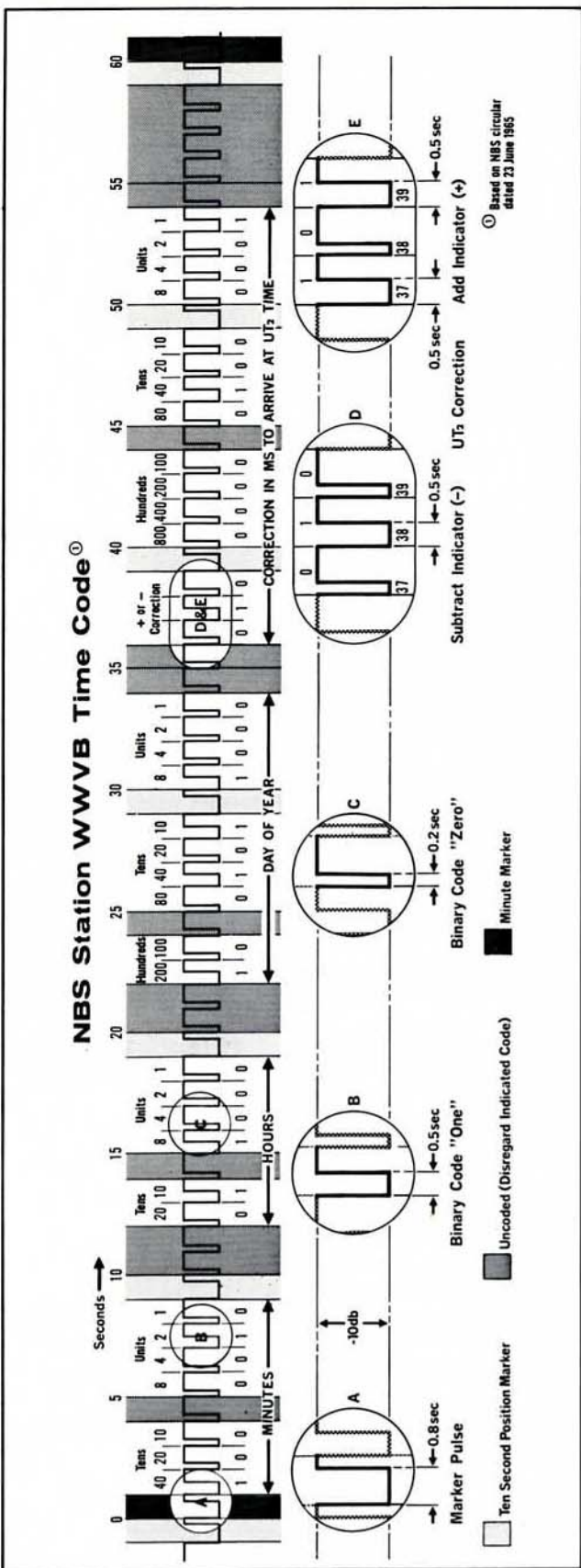

Figure III-4. WWVB Time Pulses and Coding

space (also shaded). Each area presents its information in the binary-coded-decimal (BCD) notation.

In BCD notation, the "units" information is indicated by a group of binary digits or "bits", the "tens" information by a second group of bits, the hundreds information by a third group, etc. The normal BCD group consists of four bits. However, a group of two bits can serve to represent digits 0 through 3, and three bits, digits 4 through 7. Shorter groups are often used where the largest number to be represented does not require the full set.

The bit values in each group are powers of 2, the least significant bit being $2^0 = 1$, the remaining bits $2^1 = 2$, $2^2 = 4$, $2^3 = 8$. The presence of a bit value is indicated by the binary digit "1", its absence by the binary digit "0".

The decimal digit represented by a BCD group is obtained by addition of the bit values present ($1001 = 8 + 0 + 0 + 1 = 9$; $110 = 4 + 2 + 0 = 6$; $11 = 2 + 1 = 3$). The number 461 is represented in Figure III-5 as it appears in the level-shift-carrier code, and in BCD notation, to show the correspondence between the two.

Returning to Figure III-4, we note that the number denoted in the "minutes" area is 42 (the 4th bit in the "tens" set, not needed since the largest number to be represented is 60:

Tens Set	Units Set	Number Represented
$4 \times 10 = 40$	$2 \times 1 = 2$	42

By a similar process, the "hours" area is found to read 18, and the "days" area to read 258. The code thus far (up through second 34) reads: "the 42nd minute of the 18th hour of the 258th day of the year."

The remainder of the code shows the correction in milliseconds to be applied to the time as broadcast, in order to arrive at the best approximation to UT_2 . First, the sign of the correction is indicated: a "1"

	HUNDREDS GROUP				TENS GROUP				UNITS GROUP			
Bit Value	8	4	2	1	8	4	2	1	8	4	2	1
Appearance Of Code As Broadcast:	[Pulse diagram showing binary code for 461]											
In Binary Code:	0	1	0	0	0	1	1	0	0	0	0	1
Read:	$4 \times 100 = 400$				$6 \times 10 = 60$				$1 \times 1 = 1$			
Add:	$400 + 60 + 1 = 461$											

Figure III-5. Time code - BCD correspondence

in seconds 37 and 39 designates a plus sign; the correction is to be added. A "1" in second 38 designates a minus sign; the correction is to be subtracted. Figure III-4 illustrates these indicators (encircled).

The numerical correction itself is indicated in the next area. The example shown is read to be: "Subtract 41 (milliseconds)".

This means that if we are in, say, the 35th second as broadcast, in UT₂ time the 35th interval would end 41 ms later. To state this another way, if code time is fast with respect to UT₂, we need to subtract and the subtract code will appear as a "1" broadcast in second 38. To summarize, the information presented in the example indicates that the UT₂ time (assuming again the 35th second) is:

$$258^d 19^h 42^m 34.959^s$$

for, $35.000 - 0.41 = 34.959$.

WWVB identification is an advance of the carrier phase by 45 degrees at 10 minutes after the hour, returned to normal phase at 15 minutes after the hour. The shift is initiated with a time accuracy of 1 ms and spaced with a precision of 1 μ s.

D. NBS STANDARD SIGNALS: OFFSETS AND CORRECTIONS.

The frequencies of WWV, WWVH, WWVB, and WWVL are all traceable to the USFS (see Appendix II).

Time signals are kept close to UT₂ by (1) maintaining the broadcast frequency offset from USFS (in accordance with the Bureau International de l'Heure offset announced for the year) and by (2) making 100 ms step adjustments in phase, as needed, on the first of the month. Since WWV and WWVH time signals are kept locked to transmission frequency, they may continuously depart from UT₂. Differences are determined and published by the U. S. Naval Observatory.

WWVB time signals are the international second (atomic) and are not offset. Also locked to transmission frequency, they are kept close to UT₂ by 200 ms step adjustments in phase, made on the first of the month as needed. Their difference from UT₂ is coded on the broadcasts. WWVL does not presently broadcast time signals.

Fractional frequency deviations of the NBS stations are published monthly in "Proceedings of the IEEE" under the heading, "Standard Frequency and Time Notices."

E. GEOPHYSICAL ALERT NOTIFICATIONS.

WWV and WWVH broadcast each hour in International Morse Code letter symbols that identify days on which outstanding solar or geophysical events are expected, or have occurred in the last 24 hours. The announcement is the prefix GEO followed by a letter code, for example, "GEO-SSSS", according to this scheme:

M = Magnetic storm	S = Solar activity
N = Magnetic quiet	Q = Quiet solar day
C = Cosmic ray event	W = Stratospheric warning
E = No geolert issued	

3. U.S. NAVY BROADCASTS

Five U. S. Navy high-power transmitters (refer to Table 2), operated for the purpose of communication, are being controlled by the U. S. Naval Observatory to within a part in 10^{10} of their assigned frequencies (VLF).^{*} Station NBA, located in the Canal Zone, transmits precise time signals.

The assigned frequency for each station is based upon the A. 1 time and is offset to keep to the best approximation of UT₂ time. NBA broadcasts, in International Morse, the offset to correct the transmissions from A. 1 to UT₂ time. Bulletins of the U. S. Naval Observatory, Washington, D.C., announce corrections to arrive at UT₂.

The five Navy transmitters have been operating in the interrupted or keyed continuous-wave mode; however, a change to modulation by teletype-code-keyed frequency shift has been proposed.^{**}

4. WORLDWIDE FREQUENCY & TIME BROADCASTS

Tables 1 and 2 list frequency and time standard stations and present brief information about their broadcasts.

The programs and schedules of standard stations are subject to frequent changes. Those who wish to use a specific broadcast should write to the station, requesting their current announcements regarding frequency offsets, maintenance shutdowns, etc.

^{*}R.R. Stone, Jr., "Synchronization of Local Frequency Standards with VLF Transmissions", 18th Annual Frequency Control Symposium (reported in "Frequency", July-August 1964, p. 20).

^{**}R.R. Stone, T.H. Gee, "Incorporating FSK into VLF Transmissions", 18th Annual Frequency Control Symposium (reported in "Frequency", July-August 1964, p. 20).

Table 1. Standard Frequency and Time Stations: High Frequency

Call Sign	Place	Latitude Longitude	Carrier Frequency & Power *	Operating Schedule	Modulation, Time Signals
WWV	Greenbelt, Md., USA (Note: it is planned to re- locate WWV to Ft. Collins, Colorado, by about July, 1966.)	38°59'33.16"N 76°50'52.35"W 38°59'30.22"N 76°50'52.35"W 38°59'36.1N 76°50'52.35"W 38°59'31.20"N 76°50'52.35"W 38°59'32"N 76°50'50"W 38°59'36"N 76°50'51"W	2.5 MHz (M) 5 MHz (H) 10 MHz (H) 15 MHz (H) 20 MHz (M) 25 MHz (L)	Continuous, except min 45-49 each hour. (Note: see Fig- ures 1, 2, and 3 for detailed schedule.)	At start of each 5 min, 600 Hz or 440 Hz alternately for 2 min duration (except 600 Hz for 3 min starts each hour). Time code (BCD) for 1 min starting min 7, 12, 17, etc. Tick: 1000 Hz lasts 5 ms, no tick sec 59. Tick repeats with 100 ms inter- val for sec.00. UT ₂ correction: Int. Morse Code 19th min each hour "UT ₂ AD (or) UT ₂ SU" plus 3-digit number. To arrive at UT ₂ , add (if prefix is AD) or subtract (if prefix is SU) to the Time Signal the 3 digit number, which is the correction in milliseconds.
WWVH	Maui, Hawaii, USA	20°46'N 156°28'W	2.5 MHz (L) 5 MHz (M) 10 MHz (M)	Continuous ex- cept min 15-19 each hour	440 or 600 Hz (alternately) for 3 min in each 5 min. Tick lasts 5 ms, mod. 1200 Hz. No tick sec 59.
CHU	Ottawa, Canada	45°17'47"N 75°45'22"W 7.335	3.33 MHz(M) 7.34 MHz(M) 14.670 (M)	Continuous on all frequencies	Tick is 200 ms of 1000 Hz tone. Hour mark, 1000 ms tick. Min- ute mark, 500 ms tick for sec 00. Pulses are one each sec except 29th pulse of each min. 51 to 59th of each minute, 1 to 10th pulses each hour, all omitted. Step adjustment where needed, first day of month. Voice an- nouncement each minute.
MSF	Rugby, United Kingdom	55°22'N 1°11'W	2.5 MHz 5 MHz 10 MHz (L)	Continuous, based on time sharing with HBN: MSF and HBN transmit in alternate 5 min spans. Both omit min 55-60 each hr. Thus HBN is off min 0-5, 10-15, etc.	Beginning each hr, carrier and seconds pulses for 5 min span followed by 5 min silence. Be- ginning at 9-1/2 min, call sign and amount of frequency offset (in parts in 10 ¹⁰) each given 3 times in slow Morse. Cycle repeated 6 times each hour. Tick is 5 ms of 1000 Hz, min. mark 1000 ms.
HBN	Neuchatel, Switzerland	47°00'N 6°57'E	5 MHz (M)		1 ms carrier break repeated 5 times every sec and 250 times at min, exact time being start of first break. Call sign in Morse. Step adjustment where needed.
OMA	Prague, Czecho- slovakia	50°07'N 14°35'E	2.5 MHz M	Continuous except min 40-45 each hour.	1000 Hz for 4 min in each 15 min. Tick, 5 ms of 1000 Hz tone. Min. mark, 100 ms, 500 ms every 5th min. Last 5 pulses each quarter hour, 100 ms. Call sign in Morse.

*L < 1 kW, M 1-5 kW, H > 5 kW

Table 1. Standard Frequency and Time Stations: High Frequency (cont'd)

Call Sign	Place	Latitude Longitude	Carrier Frequency & Power*	Operating Schedule	Modulation, Time Signals
FFH	Paris, France	48°59'N 02°29'E	2.5 MHz	Tues. & Fri. 9 hrs/ day except min 25-30 each hour	Tick is 5 ms of 1000 Hz modulation. Min. mark, 100 ms followed by 100 ms at 440 Hz for sec 00. Signal is for 10 min in each 20. Audio, 440 Hz (1 min) and 1000 Hz (9 min). Adjustment, 50 ms step, first Monday of month.
IAM	Rome, Italy	41°52'N	5 MHz	1 hr/day, 6 days/ week, 0730-0830	Second pulses are 5 cycles of 1000 Hz. Minute marks are 4 such pulses 5 ms apart. Time (A2) is announced in slow Morse at 0735, 0805, & 0820 UT.
IBF	Turin, Italy	45°03'N 07°40'E	5 MHz M	Last 20 min each hour: 0640-0700 ... 1640-1700 UT daily	1000 Hz for 4 min & one voice announcement on each 20 min. Tick, 5 ms of 1000 Hz tone. Min mark, normal tick repeated 7 times (with 10 ms intervals between two fronts) for sec 00. Adjustment, 100 ms steps when required.
ZUO	Johannesburg, Rep. of South Africa	26°11'S 28°04'E	10 MHz L	Continuous except min. 15-25 each hr. and 0630-0700 UT each day	Tick is 5 ms of 1000 Hz carrier, minute mark 500 ms tick. Adjustment is 100 ms step.
	Olifantsfontein, Rep. of South Africa	25°58'S 28°14'E	5 MHz M		
LOL	Buenos Aires, Argentina	34°37'18.5"S 58°21'18.3"W	5 MHz 10 MHz (M) 15 MHz	5 hours per day 6 days a week 1200-1300, 1500-1600, 1800-1900, etc.	Carrier modulation is 1000 Hz and 440 Hz alternately, for 3 min out of 5, starting at min 00, 05, 10, etc., except that min 55-59 reserved for precise time signals. A 5 ms pause (5 cycles of 1000 Hz) marks the seconds. Morse Code identification and time signals.
JJY	Tokyo, Japan	35°42'N 139°31'E	2.5 MHz 5 MHz 10 MHz 15 MHz	Continuous	
ATA	New Delhi, India	28°34'N 77°19'E	10 MHz M	5hrs/day; 5 days/wk 0534-0600 and 1030-1100 UT Continuous signal	1000 Hz ticks, duration 5 ms, min mark, 100 ms tick for sec 00. Adjustment, 50 ms step.
VNG	Lyndhurst, Australia	38°0'S 145°12'E	5.4 MHz 7.5 MHz 12.0 MHz	Continuous: 1215-2230 (5.4 MHz, 7.5 MHz) 2245-1200 (7.5 MHz, 12.0 MHz)	Sec pulses are 100 ms of 1000 Hz tone. Sec 59 is omitted to mark minutes. Voice identification for one minute at start of each hr. Phase adjust. in steps of 50-100 ms on 1st of mo. where necessary. Note: stabilized frequency service planned for future.
VHP	Belconnen, Australia	35°25'S 149°25'E	8.5 MHz (and others)	0025-0030 0755-0800 1355-1400 1955-2000 UT	Time Signals from Mt. Stromlo Observatory, transmission is A1, that is, keyed continuous wave.

*L < 1 kW, M 1-5 kW, H > 5 kW

Table 2. LF/VLF Standard Frequency and Time Stations

Call Sign	Place	Latitude Longitude	Carrier Freq. & Power	Operating Schedule	Modulation, Time Signals
WWVB	Ft. Collins, Colo. USA	40°40'28.3"N 105°02'39.5"W	60 kHz (H)	Continuous, except that on Tuesdays, WWVB and WWVL shut down for maintenance (at alternate times). Note: WWVL is an experimental station. For details of its current operation write NBS	Identification is a 45° phase advance at 10 min after the hour for a 5 min duration. Seconds are marked by a 10 dB drop in power level. Time information is presented in binary-coded-decimal notation; day of year, hour, minute, and millisecond difference from UT ₂ (see Paragraph 2-C for details).
WWVL	Ft. Collins, Colo., USA	40°41'51.3"N 105°03'00.0"W	20 kHz (M)	F&T B'cast Services, Boulder, Colorado, 80301.	Call sign at min 00 20 40 each hr.
GBR	Rugby, England	55°22'N 1°11'W	16 kHz	Continuous except approx 1300-1430 UT daily	Morse code time signals for 5 min preceding 0300, 0800, 1500, and 2300 UT.
MSF			60 kHz (M)	Daily, one hr., 1429-1530 UT (continuous operation is under consideration).	Tick is 5 ms of 1000 Hz, minute mark is 1000 ms (Note: deviations from nominal frequency for GBR, MSF, and Droitwich are published monthly in "The Radio and Electronics Engineer").
BBC	Droitwich, England	52°18'N 2°06'W	200 kHz (H)	Continuous (18-20 hours)	
DCF-77	Mainflingen, F. R. of Germany	50°01'N 09°00'E	77.5 kHz (H)	6 days a week: 0645-1035 and 1900-0010 UT (1 Nov-28 Feb) 1900-0210 UT (1 Mar - 31 Oct).	Varied program of time signals, etc., originating alternately from Physikalisch-Technischen Bundesanstalt (PTB) and Deutschen Hydrographischen Instituts (DHI). For example, A1 telegraphy time signals from PTB 0728-0735, 1028-1035, etc. and during min 57 to 59 each hour. Time signals from DHI 0700-0710, 1000-1010, etc. and during min 00-10 ea hr. Carrier with pulses every 2 min from PTB 0645 to 0659, etc. Morse Code call letters. Adjustment, 50 ms steps.
NBA	Balboa, Canal Zone, USA	08°57'N 79°34'W	24 kHz (M)		
NPM	Lualualei, Hawaii, USA	21°26'N 158°09'W	19.8 kHz (M)	Maintenance 1400-1900 each Tues.	CW beginning 1/2 hr after odd hours UT. Frequency shift keying beginning odd hours for 30 min.
NSS	Annapolis Md., USA	38°59'N 76°28'W	21.4 kHz (H)	Maintenance as required	Time signals, minutes 55-60 each hour.
NLK/ NPG	Jim Creek Wash., USA	48°06'N 122°16'W	18.6 kHz (H)	Maintenance 1600-2400 UT Thurs.	40-44 min, one 200 ms pulse each 2 sec. 44-47 min, key down 47-50 min, key up
NAA	Cutler, Maine, USA	44°38'N 66°17'W	17.8 kHz (H)	Maintenance as required.	CW beginning odd hours UT. Frequency shift keying beginning even hours UT.

*L < 1 kW, M 1-5 kW, H > 5 kW

Table 2. LF/VLF Standard Frequency and Time Stations (cont'd)

Call Sign	Place	Latitude Longitude	Carrier Frequency & Power*	Operating Schedule	Modulation, Time Signals
ZUO	Johannesburg, Rep. of S. Africa	26° 11'S	100 kHz (L)	Continuous	
RWM- RES	Moscow, USSR	55° 45'N 37° 33'E	100 kHz (H)	Continuous (21 hours per day)	Time signal 40 min in each 120.
OMA	Podebrady, Czecho.	50° 08'N 15° 08'E	50 kHz (M)	Continuous	A-1 telegraphy signals. Call sign in Morse. Step adjustment.
HBG	Prangins, Switzerland	46° 24'N 06° 15'E	75 kHz	Continuous	Time signals, 100 msec pulsed carrier marks sec, prolonged for sec 00. Note: to begin oper- ation in fall 1965.
FTK- 77	Pontoise, France	49° 04'N 2° 07'E	10.775 kHz (H)	0800 2000	Telegraphic (A1) signal, 100 ms pulse. Minute mark, 400 ms pulse. At the times indicated under "Operating Schedule", signals are broadcast consisting of 1 cycle pulses during the 5 min preceding (longer pulses every 2nd minute). Signal duration, 55 to 00, 01 to 06; and for FTN and FTA, 25 to 30, 31 to 36 also. To begin Jan. 1, 1966; trans. from min 01 to 06, 31 to 36 will be suppressed. Min 30 and 60 will be 15 sec pulse.
FTH- 42			7.428 kHz (H)	900 2100	
FTN- 87			13.873 kHz (H)	930 1300 2230	
FTA- 91	St. Andre de Corcy, France	45° 55'N 4° 55'E	91.15 kHz (H)	0800 1300 0900 2100 0930 2230	

*L < 1 kW, M 1-5 kW, H > 5 kW

APPENDIX IV

NOMOGRAPHS AND TABLES

Appendix IV contains charts and tables to assist in certain computations described in the text, such as that for the great circle distance from a transmitter to a receiver (Section IV-2). Included are a conversion chart for changing hours and minutes to micro-seconds (Figure IV-1), a nomograph for great circle distance (Figure IV-2), and three tables: Table 1, Equivalents; Table 2, Logarithms of Cosine Functions; and Table 3, Haversines.

The chart on two pages that follow simplifies the estimation of the great circle distance between two points on a sphere. As discussed in Section IV-2, it is necessary for timekeeping purposes to know the distance between a radio standards station and the receiver in order to compute the propagation delay.

This nomograph represents a graphical solution to the equation:

$$\text{hav } D = (\cos_{LA})(\cos_{LB})(\text{hav } Lo_{AB}) + \text{hav } L_{AB}$$

The numerical solution to an example problem was found in Section IV-2-A.

The use of this chart is limited to that area which includes the continental United States. To use the chart, four values must be known or calculated:

- a) Latitude of Point A
- b) Latitude of Point B
- c) Difference in longitude between Points A and B

- d) Difference in latitude between Points A and B.

To illustrate the use of the nomograph, consider the following example:

EXAMPLE:

Find the distance between radio station WWV (Point A) and Palo Alto, California (Point B).

Referring to the necessary reference we find

Lat. of A = 39° Long. of A = 76.8°
 Lat. of B = 37.4° Long. of B = 122.1°

Difference in Lat. = 1.6°
 Difference in Long. = 45.3°

Note that interpolation between chart lines may be necessary.

On sheet 1, starting with the latitude of A, move directly up to the line that represents the latitude of B (as indicated by the dotted line). From that point, move directly left to the line representing the difference in longitude. Now move directly down to the corresponding scale C on sheet 2. At the bottom of sheet 2 mark the value of the difference in latitude and connect this point by a straight line to the point on Scale C already marked. The point where this line crosses the great circle scale is the great circle distance between Points A and B. This distance may be read in degrees or in kilometers. An expanded scale (shaded) is provided for the great circle distance scale up to about 30°.

TABLE 1. EQUIVALENTS

$$1 \text{ day} = 8.64 \times 10^7 \text{ milliseconds}$$

$$= 8.64 \times 10^{10} \text{ microseconds}$$

$$1' \text{ of arc on surface of earth} = 1 \text{ nautical mile}$$

$$= 1.151 \text{ statute miles}$$

$$= 1.852 \text{ kilometers}$$

$$1^\circ \text{ of arc on surface of earth} = 60 \text{ nautical miles}$$

$$= 111.195 \text{ kilometers}$$

$$1 \text{ kilometer} = 0.6214 \text{ statute miles}$$

CHARTS TO CONVERT HOURS & MINUTES TO MICROSECONDS

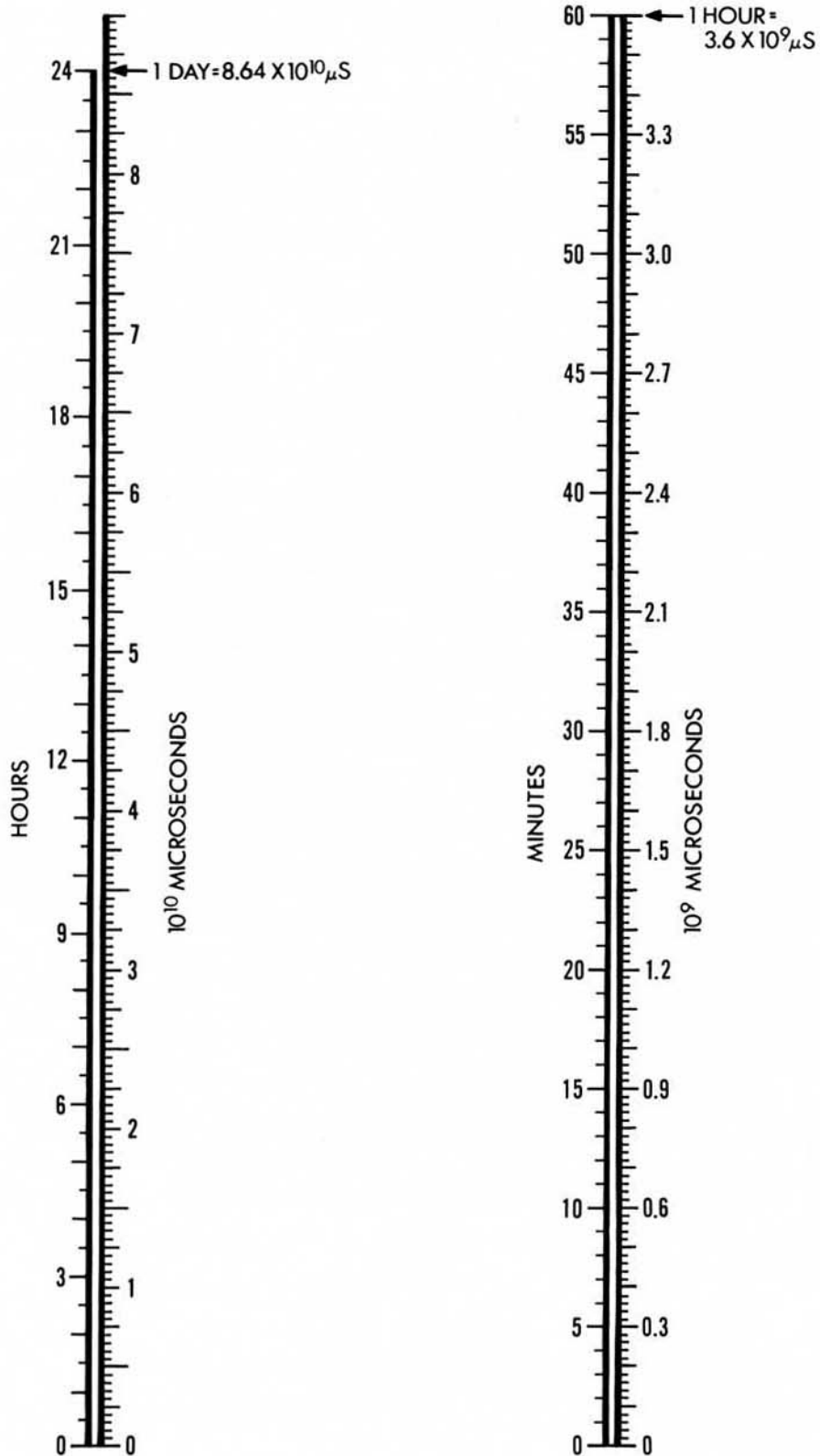

Figure IV-1. Conversion Chart - Hours & Minutes to Microseconds

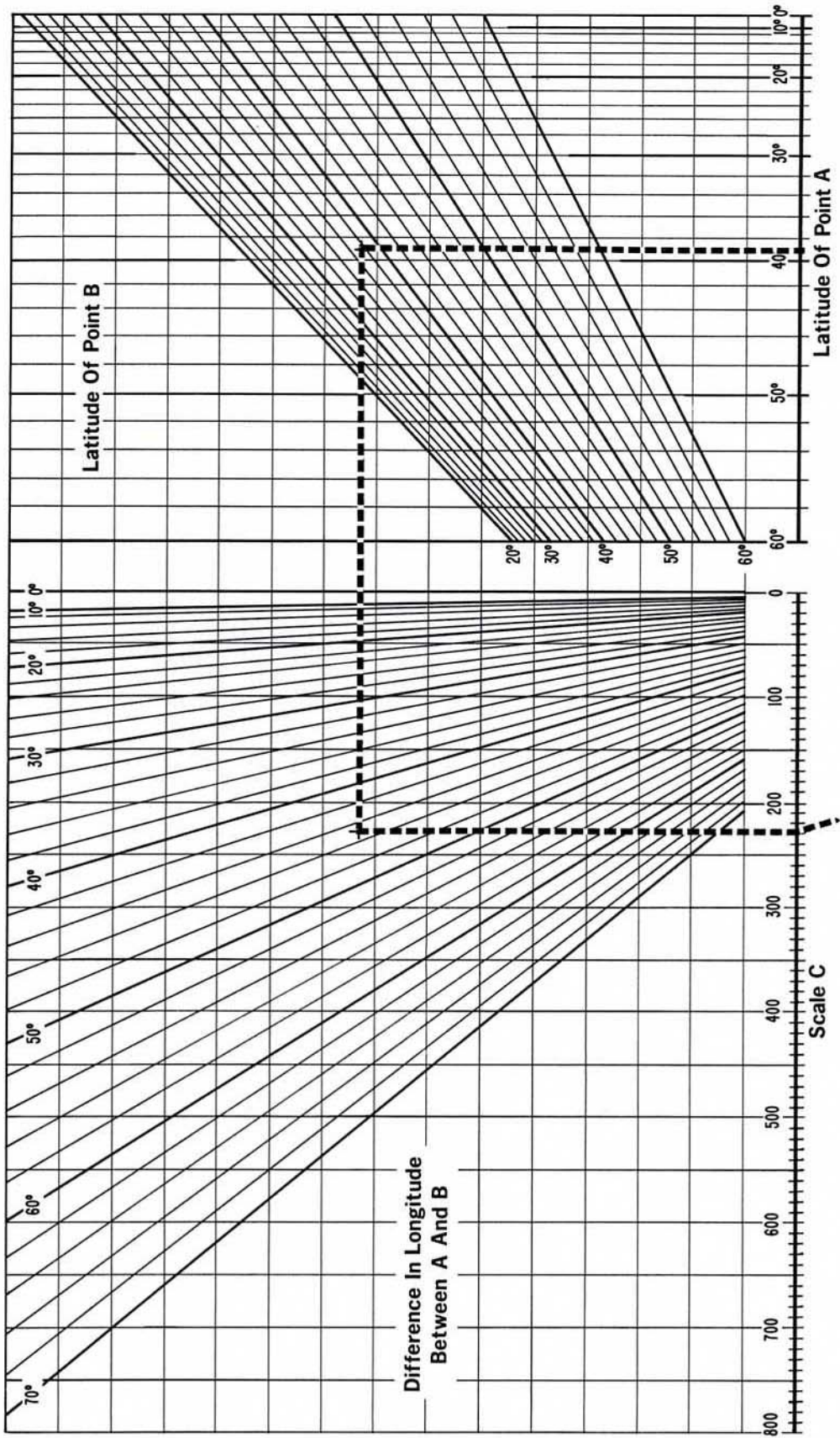

Figure IV-2. Great Circle Distance Nomograph (Sheet 1 of 2)

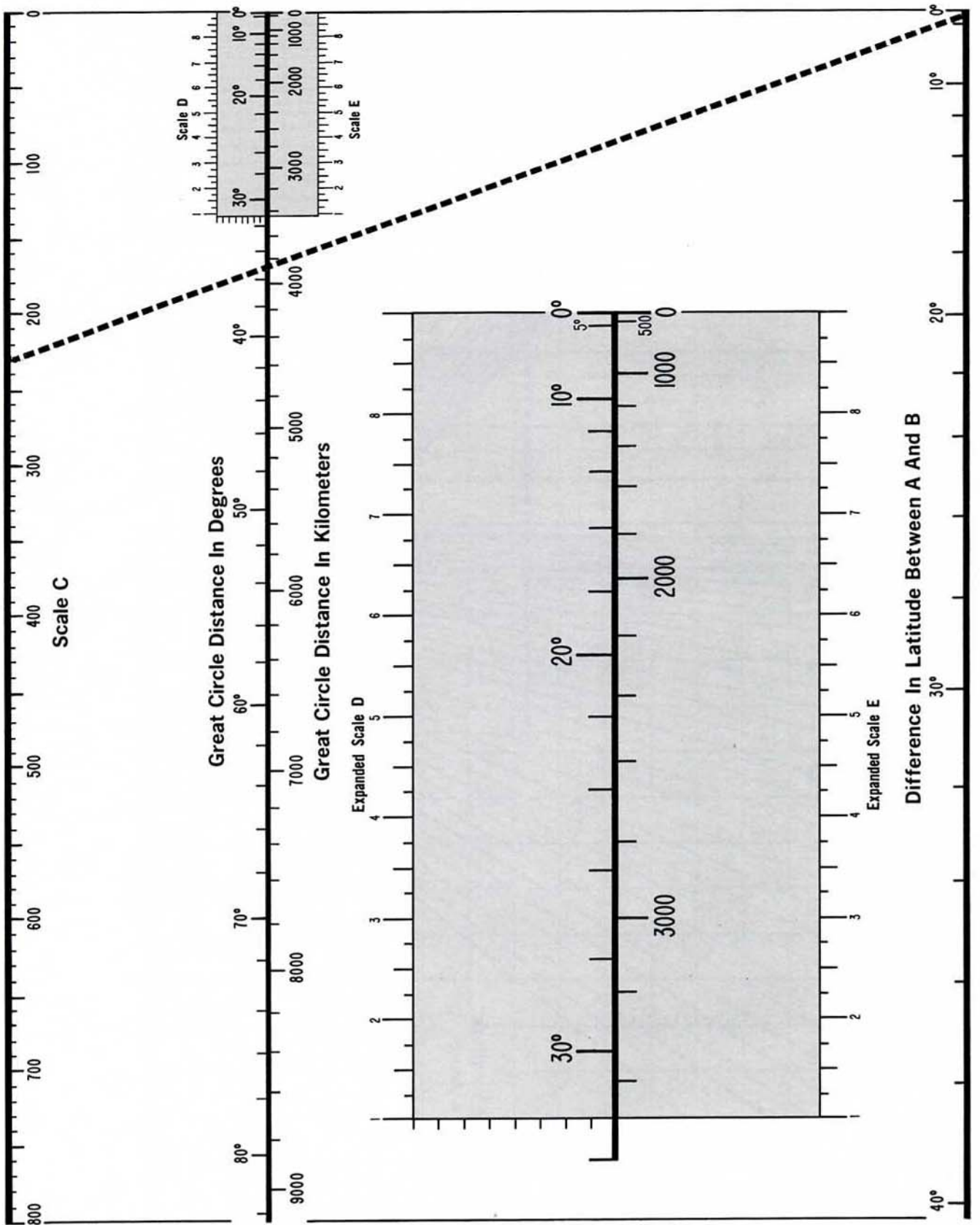

Figure IV-3. Great Circle Distance Nomograph (Sheet 2 of 2)

TABLE 2. LOGARITHMS OF COSINE FUNCTION
(0° to 45°)

Note: Append -10 to each logarithm

°	0'	10'	20'	30'	40'	50'	60'
0	0.0000	0.0000	0.0000	0.0000	0.0000	9.9999	9.9999
1	9.9999	9.9999	9.9999	9.9999	9.9998	9.9998	9.9997
2	9.9997	9.9997	9.9996	9.9996	9.9995	9.9995	9.9994
3	9.9994	9.9993	9.9993	9.9992	9.9991	9.9990	9.9989
4	9.9989	9.9989	9.9988	9.9987	9.9986	9.9985	9.9983
5	9.9983	9.9982	9.9981	9.9980	9.9979	9.9977	9.9976
6	9.9976	9.9975	9.9973	9.9972	9.9971	9.9969	9.9968
7	9.9968	9.9966	9.9964	9.9963	9.9961	9.9959	9.9958
8	9.9958	9.9956	9.9954	9.9952	9.9950	9.9948	9.9946
9	9.9946	9.9944	9.9942	9.9940	9.9938	9.9936	9.9934
10	9.9934	9.9931	9.9929	9.9927	9.9924	9.9922	9.9919
11	9.9919	9.9917	9.9914	9.9912	9.9909	9.9907	9.9904
12	9.9904	9.9901	9.9899	9.9896	9.9893	9.9890	9.9887
13	9.9887	9.9884	9.9881	9.9878	9.9875	9.9872	9.9869
14	9.9869	9.9866	9.9863	9.9859	9.9856	9.9853	9.9849
15	9.9849	9.9846	9.9843	9.9839	9.9836	9.9832	9.9828
16	9.9828	9.9825	9.9821	9.9817	9.9814	9.9810	9.9806
17	9.9806	9.9802	9.9798	9.9794	9.9790	9.9786	9.9782
18	9.9782	9.9778	9.9774	9.9770	9.9765	9.9761	9.9757
19	9.9757	9.9752	9.9748	9.9743	9.9739	9.9734	9.9730
20	9.9730	9.9725	9.9721	9.9716	9.9711	9.9706	9.9702
21	9.9702	9.9697	9.9692	9.9687	9.9682	9.9677	9.9672
22	9.9672	9.9667	9.9661	9.9656	9.9651	9.9646	9.9640
23	9.9640	9.9635	9.9629	9.9624	9.9618	9.9613	9.9607
24	9.9607	9.9602	9.9596	9.9590	9.9584	9.9579	9.9573
25	9.9573	9.9567	9.9561	9.9555	9.9549	9.9543	9.9537
26	9.9537	9.9530	9.9524	9.9518	9.9512	9.9505	9.9499
27	9.9499	9.9492	9.9486	9.9479	9.9473	9.9466	9.9459
28	9.9459	9.9453	9.9446	9.9439	9.9432	9.9425	9.9418
29	9.9418	9.9411	9.9404	9.9397	9.9390	9.9383	9.9375
30	9.9375	9.9368	9.9361	9.9353	9.9346	9.9338	9.9331
31	9.9331	9.9323	9.9315	9.9308	9.9300	9.9292	9.9284
32	9.9284	9.9276	9.9268	9.9260	9.9252	9.9244	9.9236
33	9.9236	9.9228	9.9219	9.9211	9.9203	9.9194	9.9186
34	9.9186	9.9177	9.9169	9.9160	9.9151	9.9142	9.9134
35	9.9134	9.9125	9.9116	9.9107	9.9098	9.9089	9.9080
36	9.9080	9.9070	9.9061	9.9052	9.9042	9.9033	9.9023
37	9.9023	9.9014	9.9004	9.8995	9.8985	9.8975	9.8965
38	9.8965	9.8955	9.8945	9.8935	9.8925	9.8915	9.8905
39	9.8905	9.8895	9.8884	9.8874	9.8864	9.8853	9.8843
40	9.8843	9.8832	9.8821	9.8810	9.8800	9.8789	9.8778
41	9.8778	9.8767	9.8756	9.8745	9.8733	9.8722	9.8711
42	9.8711	9.8699	9.8688	9.8676	9.8665	9.8653	9.8641
43	9.8641	9.8629	9.8618	9.8606	9.8594	9.8582	9.8569
44	9.8569	9.8557	9.8545	9.8532	9.8520	9.8507	9.8495

TABLE 2. LOGARITHMS OF COSINE FUNCTION (Cont'd)
(45° to 90°)

Note: Append -10 to each logarithm

°	0'	10'	20'	30'	40'	50'	60'
45	9.8495	9.8482	9.8469	9.8457	9.8444	9.8431	9.8418
46	9.8418	9.8405	9.8391	9.8378	9.8365	9.8351	9.8338
47	9.8338	9.8324	9.8311	9.8297	9.8283	9.8269	9.8255
48	9.8255	9.8241	9.8227	9.8213	9.8198	9.8184	9.8169
49	9.8169	9.8155	9.8140	9.8125	9.8111	9.8096	9.8081
50	9.8081	9.8066	9.8050	9.8035	9.8020	9.8004	9.7989
51	9.7989	9.7973	9.7957	9.7941	9.7926	9.7910	9.7893
52	9.7893	9.7877	9.7861	9.7844	9.7828	9.7811	9.7795
53	9.7795	9.7778	9.7761	9.7744	9.7727	9.7710	9.7692
54	9.7692	9.7675	9.7657	9.7640	9.7622	9.7604	9.7586
55	9.7586	9.7568	9.7550	9.7531	9.7513	9.7494	9.7476
56	9.7476	9.7457	9.7438	9.7419	9.7400	9.7380	9.7361
57	9.7361	9.7342	9.7322	9.7302	9.7282	9.7262	9.7242
58	9.7242	9.7222	9.7201	9.7181	9.7160	9.7139	9.7118
59	9.7118	9.7097	9.7076	9.7055	9.7033	9.7012	9.6990
60	9.6990	9.6968	9.6946	9.6923	9.6901	9.6878	9.6856
61	9.6856	9.6833	9.6810	9.6787	9.6763	9.6740	9.6716
62	9.6716	9.6692	9.6668	9.6644	9.6620	9.6595	9.6570
63	9.6570	9.6546	9.6521	9.6495	9.6470	0.6442	9.6418
64	9.6418	9.6392	9.6366	9.6340	9.6313	9.6286	9.6259
65	9.6259	9.6232	9.6205	9.6177	9.6149	9.6121	9.6093
66	9.6093	9.6065	9.6036	9.6007	9.5978	9.5948	9.5919
67	9.5919	9.5889	9.5859	9.5828	9.5798	9.5767	9.5736
68	9.5736	9.5704	9.5673	9.5641	9.5609	9.5576	9.5543
69	9.5543	9.5510	9.5477	9.5443	9.5409	9.5375	9.5341
70	9.5341	9.5306	9.5270	9.5235	9.5199	9.5163	9.5126
71	9.5126	9.5090	9.5052	9.5015	9.4977	9.4939	9.4900
72	9.4900	9.4861	9.4821	9.4781	9.4741	9.4700	9.4659
73	9.4659	9.4618	9.4576	9.4533	9.4491	9.4447	9.4403
74	9.4403	9.4359	9.4314	9.4269	9.4223	9.4177	9.4130
75	9.4130	9.4083	9.4035	9.3986	9.3937	9.3887	9.3837
76	9.3837	9.3786	9.3734	9.3682	9.3629	9.3575	9.3521
77	9.3521	9.3466	9.3410	9.3353	9.3296	9.3238	9.3179
78	9.3179	9.3119	9.3058	9.2997	9.2934	9.2870	9.2806
79	9.2806	9.2740	9.2674	9.2606	9.2538	9.2468	9.2397
80	9.2397	9.2324	9.2251	9.2176	9.2100	9.2022	9.1943
81	9.1943	9.1863	9.1781	9.1697	9.1612	9.1525	9.1436
82	9.1436	9.1345	9.1252	9.1157	9.1060	9.0961	9.0859
83	9.0859	9.0755	9.0648	9.0539	9.0426	9.0311	9.0192
84	9.0192	9.0070	8.9945	8.9816	8.9682	8.9545	8.9403
85	8.9403	8.9256	8.9104	8.8946	8.8783	8.8613	8.8436
86	8.8436	8.8251	8.8059	8.7857	8.7645	8.7423	8.7188
87	8.7188	8.6940	8.6677	8.6397	8.6097	8.5776	8.5428
88	8.5428	8.5050	8.4637	8.4179	8.3668	8.3088	8.2419
89	8.2419	8.1627	8.0658	7.9408	7.7648	7.4637	--

TABLE 3. HAVERSINES
(0° to 44°)

Note: Characteristics of the logarithms are omitted.

°	0'		10'		20'		30'		40'		50'	
	Nat	Log	Nat	Log	Nat	Log	Nat	Log	Nat	Log	Nat	Log
0	.0000	—	.0000	$\bar{6}$.3254	.0000	$\bar{6}$.9275	.0000	$\bar{5}$.2796	.0000	$\bar{5}$.5295	.0001	$\bar{5}$.7233
1	.0001	$\bar{5}$.8817	.0001	.0156	.0001	.1316	.0002	.2339	.0002	.3254	.0003	.4081
2	.0003	.4837	.0004	.5532	.0004	.6176	.0005	.6775	.0005	.7336	.0006	.7862
3	.0007	.8358	.0008	.8828	.0008	.9273	.0009	.9697	.0010	.0101	.0011	.0487
4	.0012	.0856	.0013	.1211	.0014	.1551	.0015	.1879	.0017	.2195	.0018	.2499
5	.0019	.2794	.0020	.3078	.0022	.3354	.0023	.3621	.0024	.3880	.0026	.4132
6	.0027	.4376	.0029	.4614	.0031	.4845	.0032	.5071	.0034	.5290	.0036	.5504
7	.0037	.5714	.0039	.5918	.0041	.6117	.0043	.6312	.0045	.6503	.0047	.6689
8	.0049	.6872	.0051	.7051	.0053	.7226	.0055	.7397	.0057	.7566	.0059	.7731
9	.0062	.7893	.0064	.8052	.0066	.8208	.0069	.8361	.0071	.8512	.0073	.8660
10	.0076	.8806	.0079	.8949	.0081	.9090	.0084	.9229	.0086	.9365	.0089	.9499
11	.0092	.9631	.0095	.9762	.0097	.9890	.0100	.0016	.0103	.0141	.0106	.0264
12	.0109	.0385	.0112	.0504	.0115	.0622	.0119	.0738	.0122	.0852	.0125	.0966
13	.0128	.1077	.0131	.1187	.0135	.1296	.0138	.1404	.0142	.1510	.0145	.1614
14	.0149	.1718	.0152	.1820	.0156	.1921	.0159	.2021	.0163	.2120	.0167	.2217
15	.0170	.2314	.0174	.2409	.0178	.2504	.0182	.2597	.0186	.2689	.0190	.2781
16	.0194	.2871	.0198	.2961	.0202	.3049	.0206	.3137	.0210	.3223	.0214	.3309
17	.0218	.3394	.0223	.3478	.0227	.3561	.0231	.3644	.0236	.3726	.0240	.3807
18	.0245	.3887	.0249	.3966	.0254	.4045	.0258	.4123	.0263	.4200	.0268	.4276
19	.0272	.4352	.0277	.4427	.0282	.4502	.0287	.4576	.0292	.4649	.0297	.4721
20	.0302	.4793	.0307	.4865	.0312	.4935	.0317	.5006	.0322	.5075	.0327	.5144
21	.0332	.5213	.0337	.5281	.0343	.5348	.0348	.5415	.0353	.5481	.0359	.5547
22	.0364	.5612	.0370	.5677	.0375	.5741	.0381	.5805	.0386	.5868	.0392	.5931
23	.0397	.5993	.0403	.6055	.0409	.6116	.0415	.6177	.0421	.6238	.0426	.6298
24	.0432	.6358	.0438	.6417	.0444	.6476	.0450	.6534	.0456	.6592	.0462	.6650
25	.0468	.6707	.0475	.6764	.0481	.6820	.0487	.6876	.0493	.6932	.0500	.6987
26	.0506	.7042	.0512	.7096	.0519	.7150	.0525	.7204	.0532	.7258	.0538	.7311
27	.0545	.7364	.0552	.7416	.0558	.7468	.0565	.7520	.0572	.7572	.0578	.7623
28	.0585	.7674	.0592	.7724	.0599	.7774	.0606	.7824	.0613	.7874	.0620	.7923
29	.0627	.7972	.0634	.8021	.0641	.8069	.0648	.8117	.0655	.8165	.0663	.8213
30	.0670	.8260	.0677	.8307	.0684	.8354	.0692	.8400	.0699	.8446	.0707	.8492
31	.0714	.8538	.0722	.8583	.0729	.8629	.0737	.8673	.0744	.8718	.0752	.8763
32	.0760	.8807	.0767	.8851	.0775	.8894	.0783	.8938	.0791	.8981	.0799	.9024
33	.0807	.9067	.0815	.9109	.0823	.9152	.0831	.9194	.0839	.9236	.0847	.9277
34	.0855	.9319	.0863	.9360	.0871	.9401	.0879	.9442	.0888	.9482	.0896	.9523
35	.0904	.9563	.0913	.9603	.0921	.9643	.0929	.9682	.0938	.9721	.0946	.9761
36	.0955	.9800	.0963	.9838	.0972	.9877	.0981	.9915	.0989	.9954	.0998	.9992
37	.1007	.0030	.1016	.0067	.1024	.0105	.1033	.0142	.1042	.0179	.1051	.0216
38	.1060	.0253	.1069	.0289	.1078	.0326	.1087	.0362	.1096	.0398	.1105	.0434
39	.1114	.0470	.1123	.0505	.1133	.0541	.1142	.0576	.1151	.0611	.1160	.0646
40	.1170	.0681	.1179	.0716	.1189	.0750	.1198	.0784	.1207	.0819	.1217	.0853
41	.1226	.0887	.1236	.0920	.1246	.0954	.1255	.0987	.1265	.1020	.1275	.1054
42	.1284	.1087	.1294	.1119	.1304	.1152	.1314	.1185	.1323	.1217	.1333	.1249
43	.1343	.1282	.1353	.1314	.1363	.1345	.1373	.1377	.1383	.1409	.1393	.1440
44	.1403	.1472	.1413	.1503	.1424	.1534	.1434	.1565	.1444	.1596	.1454	.1626

TABLE 3. HAVERSINES (Cont'd)
(45° to 89°)

Note: Characteristics of the logarithms are omitted.

°	0'		10'		20'		30'		40'		50'	
	Nat	Log	Nat	Log	Nat	Log	Nat	Log	Nat	Log	Nat	Log
45	.1464	.1657	.1475	.1687	.1485	.1718	.1495	.1748	.1506	.1778	.1516	.1808
46	.1527	.1838	.1537	.1867	.1548	.1897	.1558	.1926	.1569	.1956	.1579	.1985
47	.1590	.2014	.1601	.2043	.1611	.2072	.1622	.2101	.1633	.2129	.1644	.2158
48	.1654	.2186	.1665	.2215	.1676	.2243	.1687	.2271	.1698	.2299	.1709	.2327
49	.1720	.2355	.1731	.2382	.1742	.2410	.1753	.2437	.1764	.2465	.1775	.2492
50	.1786	.2519	.1797	.2546	.1808	.2573	.1820	.2600	.1831	.2627	.1842	.2653
51	.1853	.2680	.1865	.2706	.1876	.2732	.1887	.2759	.1899	.2785	.1910	.2811
52	.1922	.2837	.1933	.2863	.1945	.2888	.1956	.2914	.1968	.2940	.1979	.2965
53	.1991	.2991	.2003	.3016	.2014	.3041	.2026	.3066	.2038	.3091	.2049	.3116
54	.2061	.3141	.2073	.3166	.2085	.3190	.2096	.3215	.2108	.3239	.2120	.3264
55	.2132	.3288	.2144	.3312	.2156	.3336	.2168	.3361	.2180	.3384	.2192	.3408
56	.2204	.3432	.2216	.3456	.2228	.3480	.2240	.3503	.2252	.3527	.2265	.3550
57	.2277	.3573	.2289	.3596	.2301	.3620	.2314	.3643	.2326	.3666	.2338	.3689
58	.2350	.3711	.2363	.3734	.2375	.3757	.2388	.3779	.2400	.3802	.2412	.3824
59	.2425	.3847	.2437	.3869	.2450	.3891	.2462	.3913	.2475	.3935	.2487	.3957
60	.2500	.3979	.2513	.4001	.2525	.4023	.2538	.4045	.2551	.4066	.2563	.4088
61	.2576	.4109	.2589	.4131	.2601	.4152	.2614	.4173	.2627	.4195	.2640	.4216
62	.2653	.4237	.2665	.4258	.2678	.4279	.2691	.4300	.2704	.4320	.2717	.4341
63	.2730	.4362	.2743	.4382	.2756	.4403	.2769	.4423	.2782	.4444	.2795	.4464
64	.2808	.4484	.2821	.4504	.2834	.4524	.2847	.4545	.2861	.4565	.2874	.4584
65	.2887	.4604	.2900	.4624	.2913	.4644	.2927	.4664	.2940	.4683	.2953	.4703
66	.2966	.4722	.2980	.4742	.2993	.4761	.3006	.4780	.3020	.4799	.3033	.4819
67	.3046	.4838	.3060	.4857	.3073	.4876	.3087	.4895	.3100	.4914	.3113	.4932
68	.3127	.4951	.3140	.4970	.3154	.4989	.3167	.5007	.3181	.5026	.3195	.5044
69	.3208	.5063	.3222	.5081	.3235	.5099	.3249	.5117	.3263	.5136	.3276	.5154
70	.3290	.5172	.3304	.5190	.3317	.5208	.3331	.5226	.3345	.5244	.3358	.5261
71	.3372	.5279	.3386	.5297	.3400	.5314	.3413	.5332	.3427	.5349	.3441	.5367
72	.3455	.5384	.3469	.5402	.3483	.5419	.3496	.5436	.3510	.5454	.3524	.5471
73	.3538	.5488	.3552	.5505	.3566	.5522	.3580	.5539	.3594	.5556	.3608	.5572
74	.3622	.5589	.3636	.5606	.3650	.5623	.3664	.5639	.3678	.5656	.3692	.5672
75	.3706	.5689	.3720	.5705	.3734	.5722	.3748	.5738	.3762	.5754	.3776	.5771
76	.3790	.5787	.3805	.5803	.3819	.5819	.3833	.5835	.3847	.5851	.3861	.5867
77	.3875	.5883	.3889	.5899	.3904	.5915	.3918	.5930	.3932	.5946	.3946	.5962
78	.3960	.5977	.3975	.5993	.3989	.6009	.4003	.6024	.4017	.6039	.4032	.6055
79	.4046	.6070	.4060	.6086	.4075	.6101	.4089	.6116	.4103	.6131	.4117	.6146
80	.4132	.6161	.4146	.6176	.4160	.6191	.4175	.6206	.4189	.6221	.4203	.6236
81	.4218	.6251	.4232	.6266	.4247	.6280	.4261	.6295	.4275	.6310	.4290	.6324
82	.4304	.6339	.4319	.6353	.4333	.6368	.4347	.6382	.4362	.6397	.4376	.6411
83	.4391	.6425	.4405	.6440	.4420	.6454	.4434	.6468	.4448	.6482	.4463	.6496
84	.4477	.6510	.4492	.6524	.4506	.6538	.4521	.6552	.4535	.6566	.4550	.6580
85	.4564	.6594	.4579	.6607	.4593	.6621	.4608	.6635	.4622	.6648	.4637	.6662
86	.4651	.6676	.4666	.6689	.4680	.6703	.4695	.6716	.4709	.6730	.4724	.6743
87	.4738	.6756	.4753	.6770	.4767	.6783	.4782	.6796	.4796	.6809	.4811	.6822
88	.4826	.6835	.4840	.6848	.4855	.6862	.4869	.6875	.4884	.6887	.4898	.6900
89	.4913	.6913	.4927	.6926	.4942	.6939	.4956	.6952	.4971	.6964	.4985	.6977

TABLE 3. HAVERSINES (Con't)
(90° to 134°)

Note: Characteristics of the logarithms are omitted.

°	0'		10'		20'		30'		40'		50'	
	Nat	Log	Nat	Log	Nat	Log	Nat	Log	Nat	Log	Nat	Log
90	.5000	.6990	.5015	.7002	.5029	.7015	.5044	.7027	.5058	.7040	.5073	.7052
91	.5087	.7065	.5102	.7077	.5116	.7090	.5131	.7102	.5145	.7114	.5160	.7126
92	.5174	.7139	.5189	.7151	.5204	.7156	.5218	.7175	.5233	.7187	.5247	.7199
93	.5262	.7211	.5276	.7223	.5291	.7235	.5305	.7247	.5320	.7259	.5334	.7271
94	.5349	.7283	.5363	.7294	.5378	.7306	.5392	.7318	.5407	.7329	.5421	.7341
95	.5436	.7353	.5450	.7364	.5465	.7376	.5479	.7387	.5494	.7399	.5508	.7410
96	.5523	.7421	.5537	.7433	.5552	.7444	.5566	.7455	.5580	.7467	.5595	.7478
97	.5609	.7489	.5624	.7500	.5638	.7511	.5653	.7523	.5667	.7534	.5681	.7545
98	.5696	.7556	.5710	.7567	.5725	.7577	.5739	.7588	.5753	.7599	.5768	.7610
99	.5782	.7621	.5797	.7632	.5811	.7642	.5825	.7653	.5840	.7664	.5854	.7674
100	.5868	.7685	.5883	.7696	.5897	.7706	.5911	.7717	.5925	.7727	.5940	.7738
101	.5954	.7748	.5968	.7759	.5983	.7769	.5997	.7779	.6011	.7790	.6025	.7800
102	.6040	.7810	.6054	.7820	.6068	.7830	.6082	.7841	.6096	.7851	.6111	.7861
103	.6125	.7871	.6139	.7881	.6153	.7891	.6167	.7901	.6181	.7911	.6195	.7921
104	.6210	.7931	.6224	.7940	.6238	.7950	.6252	.7960	.6266	.7970	.6280	.7980
105	.6294	.7989	.6308	.7999	.6322	.8009	.6336	.8018	.6350	.8028	.6364	.8037
106	.6378	.8047	.6392	.8056	.6406	.8066	.6420	.8075	.6434	.8085	.6448	.8094
107	.6462	.8104	.6476	.8113	.6490	.8122	.6504	.8131	.6517	.8141	.6531	.8150
108	.6545	.8159	.6559	.8168	.6573	.8177	.6587	.8187	.6600	.8196	.6614	.8205
109	.6628	.8214	.6642	.8223	.6655	.8232	.6669	.8241	.6683	.8250	.6696	.8258
110	.6710	.8267	.6724	.8276	.6737	.8285	.6751	.8294	.6765	.8302	.6778	.8311
111	.6792	.8320	.6805	.8329	.6819	.8337	.6833	.8346	.6846	.8354	.6860	.8363
112	.6873	.8371	.6887	.8380	.6900	.8388	.6913	.8399	.6927	.8405	.6940	.8414
113	.6954	.8422	.6967	.8430	.6980	.8439	.6994	.8447	.7007	.8455	.7020	.8464
114	.7034	.8472	.7047	.8480	.7060	.8488	.7073	.8496	.7087	.8504	.7100	.8513
115	.7113	.8521	.7126	.8529	.7139	.8537	.7153	.8545	.7166	.8553	.7179	.8561
116	.7192	.8568	.7205	.8576	.7218	.8584	.7231	.8592	.7244	.8600	.7257	.8608
117	.7270	.8615	.7283	.8623	.7296	.8631	.7309	.8638	.7322	.8646	.7335	.8654
118	.7347	.8661	.7360	.8669	.7373	.8676	.7386	.8684	.7399	.8691	.7411	.8699
119	.7424	.8706	.7437	.8714	.7449	.8721	.7462	.8729	.7475	.8736	.7487	.8743
120	.7500	.8751	.7513	.8758	.7525	.8765	.7538	.8772	.7550	.8780	.7563	.8787
121	.7575	.8794	.7588	.8801	.7600	.8808	.7612	.8815	.7625	.8822	.7637	.8829
122	.7650	.8836	.7662	.8843	.7674	.8850	.7686	.8857	.7699	.8864	.7711	.8871
123	.7723	.8878	.7735	.8885	.7748	.8892	.7760	.8898	.7772	.8905	.7784	.8912
124	.7796	.8919	.7808	.8925	.7820	.8932	.7832	.8939	.7844	.8945	.7856	.8952
125	.7868	.8959	.7880	.8965	.7892	.8972	.7904	.8978	.7915	.8985	.7927	.8991
126	.7939	.8998	.7951	.9004	.7962	.9010	.7974	.9017	.7986	.9023	.7997	.9030
127	.8009	.9036	.8021	.9042	.8032	.9048	.8044	.9055	.8055	.9061	.8067	.9067
128	.8078	.9073	.8090	.9079	.8101	.9085	.8113	.9092	.8124	.9098	.8135	.9104
129	.8147	.9110	.8158	.9116	.8169	.9122	.8180	.9128	.8192	.9134	.8203	.9140
130	.8214	.9146	.8225	.9151	.8236	.9157	.8247	.9163	.8258	.9169	.8269	.9175
131	.8280	.9180	.8291	.9186	.8302	.9192	.8313	.9198	.8324	.9203	.8335	.9209
132	.8346	.9215	.8356	.9220	.8367	.9226	.8378	.9231	.8389	.9237	.8399	.9242
133	.8410	.9248	.8421	.9253	.8431	.9259	.8442	.9264	.8452	.9270	.8463	.9275
134	.8473	.9281	.8484	.9286	.8494	.9291	.8505	.9297	.8515	.9302	.8525	.9307

TABLE 3. HAVERSINES (Cont'd)
(135° to 180°)

Note: Characteristics of the logarithms are omitted.

°	0'		10'		20'		30'		40'		50'	
	Nat	Log	Nat	Log	Nat	Log	Nat	Log	Nat	Log	Nat	Log
135	.8536	.9312	.8546	.9318	.8556	.9323	.8566	.9328	.8576	.9333	.8587	.9338
136	.8597	.9343	.8607	.9348	.8617	.9353	.8627	.9359	.8637	.9364	.8647	.9369
137	.8657	.9374	.8667	.9379	.8677	.9383	.8686	.9388	.8696	.9393	.8706	.9398
138	.8716	.9403	.8725	.9408	.8735	.9413	.8745	.9417	.8754	.9422	.8764	.9427
139	.8774	.9432	.8783	.9436	.8793	.9441	.8802	.9446	.8811	.9450	.8821	.9455
140	.8830	.9460	.8840	.9464	.8849	.9469	.8858	.9473	.8867	.9478	.8877	.9482
141	.8886	.9487	.8895	.9491	.8904	.9496	.8913	.9500	.8922	.9505	.8931	.9509
142	.8940	.9513	.8949	.9518	.8958	.9522	.8967	.9526	.8976	.9531	.8984	.9535
143	.8993	.9539	.9002	.9543	.9011	.9548	.9019	.9552	.9028	.9556	.9037	.9560
144	.9045	.9564	.9054	.9568	.9062	.9572	.9071	.9576	.9079	.9580	.9087	.9584
145	.9096	.9588	.9104	.9592	.9112	.9596	.9121	.9600	.9129	.9604	.9137	.9608
146	.9145	.9612	.9153	.9616	.9161	.9620	.9169	.9623	.9177	.9627	.9185	.9631
147	.9193	.9635	.9201	.9638	.9209	.9642	.9217	.9646	.9225	.9650	.9233	.9653
148	.9240	.9657	.9248	.9660	.9256	.9664	.9263	.9668	.9271	.9671	.9278	.9675
149	.9286	.9678	.9293	.9682	.9301	.9685	.9308	.9689	.9316	.9692	.9323	.9695
150	.9330	.9699	.9337	.9702	.9345	.9706	.9352	.9709	.9359	.9712	.9366	.9716
151	.9373	.9719	.9380	.9722	.9387	.9725	.9394	.9729	.9401	.9732	.9408	.9735
152	.9415	.9738	.9422	.9741	.9428	.9744	.9435	.9747	.9442	.9751	.9448	.9754
153	.9455	.9757	.9462	.9760	.9468	.9763	.9475	.9766	.9481	.9769	.9488	.9772
154	.9494	.9774	.9500	.9777	.9507	.9780	.9513	.9783	.9519	.9786	.9525	.9789
155	.9532	.9792	.9538	.9794	.9544	.9797	.9550	.9800	.9556	.9803	.9562	.9805
156	.9568	.9808	.9574	.9811	.9579	.9813	.9585	.9816	.9591	.9819	.9597	.9821
157	.9603	.9824	.9608	.9826	.9614	.9829	.9619	.9831	.9625	.9834	.9630	.9836
158	.9636	.9839	.9641	.9841	.9647	.9844	.9652	.9846	.9657	.9849	.9663	.9851
159	.9668	.9853	.9673	.9856	.9678	.9858	.9683	.9860	.9688	.9863	.9693	.9865
160	.9698	.9867	.9703	.9869	.9708	.9871	.9713	.9874	.9718	.9876	.9723	.9878
161	.9728	.9880	.9732	.9882	.9737	.9884	.9742	.9886	.9746	.9888	.9751	.9890
162	.9755	.9892	.9760	.9894	.9764	.9896	.9769	.9898	.9773	.9900	.9777	.9902
163	.9782	.9904	.9786	.9906	.9790	.9908	.9794	.9910	.9798	.9911	.9802	.9913
164	.9806	.9915	.9810	.9917	.9814	.9919	.9818	.9920	.9822	.9922	.9826	.9924
165	.9830	.9925	.9833	.9927	.9837	.9929	.9841	.9930	.9844	.9932	.9848	.9933
166	.9851	.9935	.9855	.9937	.9858	.9938	.9862	.9940	.9865	.9941	.9869	.9943
167	.9872	.9944	.9875	.9945	.9878	.9947	.9881	.9948	.9885	.9950	.9888	.9951
168	.9891	.9952	.9894	.9954	.9897	.9955	.9900	.9956	.9903	.9957	.9905	.9959
169	.9908	.9960	.9911	.9961	.9914	.9962	.9916	.9963	.9919	.9965	.9921	.9966
170	.9924	.9967	.9927	.9968	.9929	.9969	.9931	.9970	.9934	.9971	.9936	.9972
171	.9938	.9973	.9941	.9974	.9943	.9975	.9945	.9976	.9947	.9977	.9949	.9978
172	.9951	.9979	.9953	.9980	.9955	.9981	.9957	.9981	.9959	.9982	.9961	.9983
173	.9963	.9984	.9964	.9985	.9966	.9985	.9968	.9986	.9969	.9987	.9971	.9987
174	.9973	.9988	.9974	.9989	.9976	.9989	.9977	.9990	.9978	.9991	.9980	.9991
175	.9981	.9992	.9982	.9992	.9983	.9993	.9985	.9993	.9986	.9994	.9987	.9994
176	.9988	.9995	.9989	.9995	.9990	.9996	.9991	.9996	.9992	.9996	.9992	.9997
177	.9993	.9997	.9994	.9997	.9995	.9998	.9995	.9998	.9996	.9998	.9996	.9998
178	.9997	.9999	.9997	.9999	.9998	.9999	.9998	.9999	.9999	.9999	.9999	.9999
179	.9999	.9999	.9999	.9999	1.0000	.0000	1.0000	.0000	1.0000	.0000	1.0000	.0000
180	1.0000	.0000										

APPENDIX V

DEFINITIONS

To assist the reader who is unfamiliar with some of the terms given special meanings in the area of frequency and time standards, a set of brief definitions is presented. These definitions do not aspire to any status higher than that accorded simple working tools. Reference to publications of the Engineering Societies, the National Bureau of Standards, etc., should be made for definitive statements.

- A-1 OR A. 1 - Atomic time scale maintained by the U. S. Naval Observatory, presently based upon weighted averages of frequencies from cesium beam devices operated at a number of laboratories.
- ACCURACY - For a measured or calculated value, the degree to which it conforms to the accepted standard or rule.
- BCD - In the binary coded decimal system, individual decimal digits are represented by some binary code. For example, 16 might be represented in an 8-4-2-1 BCD notation as 0001 (for 1) and 0110 (for 6). In pure binary, 16 is 10000.
- ET - Ephemeris Time is astronomical time based upon the motion of the earth about the sun during the tropical year 1900; see Appendix I. The second of ET is apparently invariant.
- EPOCH - Usually denotes the interval elapsed from an arbitrary origin; that is, the lapse of time between event (1) and event (2) is referred to as the "epoch". The origin is customarily stated in terms of a natural phenomenon common to all observers.
- ERROR - The difference between the true value and an observed or calculated one.
- FRACTIONAL FREQUENCY DEVIATION - Statements of stability (hence quality) for frequency standards usually are made in terms of "RMS fractional frequency deviation" based upon a statistical approach.
- FREQUENCY OFFSET - Fractional frequency offset is the amount by which a frequency lies above or below reference frequency. For example, if a frequency measures 1.000 001 MHz when compared against a reference frequency of 1.000 000 MHz, then its fractional frequency offset is 1 Hz/1 MHz or 1 part in 10^6 .
- NBS-A - Atomic time scale kept by NBS, presently based upon four quartz oscillators and one Rb standard which are frequency compared daily against the USFS (cesium beam). The cycles are counted (an accumulated total is kept) and a suitable weighted average is taken (a computer program is used).
- NBS-SA - "Stepped Atomic" time signals are broadcast on NBS station WWVB. These signals are in accordance with NBS-A, which is based upon the U. S. Frequency Standard; a 0.2 sec step in phase is made on the first of the month as necessary to keep ticks within 0.1 sec of UT_2 .
- NBS-UA - The Universal Atomic Time scale of NBS is referenced to the U.S. Frequency Standard and incorporates the frequency offsets and shifts in epoch as announced by the Bureau International de l'Heure; thus NBS-UA is an approximation to UT_2 .
- PHASE ANOMALY - A sudden irregularity in the phase of a LF/VLF transmission.
- PHASE NOISE - A measure of the random phase instability of a signal.
- PRECISION, REPRODUCIBILITY, RESETTABILITY - The subtle distinctions of these terms and their relationships have been the subject of much discussion over the years; it would be inappropriate to attempt their reconciliation here. All imply the existence of an observation consisting of a series of readings taken in a prescribed manner.

PRECISION,
REPRODUCIBILITY,
RESETTABILITY

PRECISION - a quality of sharpness of definition; it relates to the measurement process, not just to an instrument; it incorporates the random error of a reading.

REPRODUCIBILITY - A sequence of comparisons (as of an instrument against a standard) will yield a mean and a standard deviation; the latter may be called the reproducibility of the instrument. Use of this term implies that the instrument was independently adjusted between comparisons, so the resettability of the instrument is a factor.

STABILITY, SHORT-TERM
AND LONG-TERM -

The stability of a frequency or time standard is one of its most important characteristics.

LONG-TERM STABILITY - Or, long-term instability, refers to the low changes in average frequency with time arising from changes in the resonator or other element of an oscillator. Statements of long-term stability for quartz oscillators often term this characteristic "aging rate" and specify it as "parts per day" (fractional frequency change over 24 hours). For cesium standards, this term commonly refers to total fractional frequency drift for the life of the cesium beam tube.

SHORT-TERM STABILITY - Or, short-term instability, is an expression of the change in average frequency over a time sufficiently short (but exceeding some minimum time) that long-term effects are of small significance. Since at present there is no general agreement fixing the averaging time, one must be specified for each statement of short-term stability. A typical statement for an ultraprecise quartz oscillator is:

"fractional frequency deviation is 1 part in 10^{11} for an 0.1 sec averaging time and is 5 parts in 10^{11} per day."

STANDARDS

Standards of frequency and time are designated in a variety of ways.

HOUSE STANDARD - A house or company frequency or time standard is the best (most nearly accurate and stable, lowest drift, etc.) frequency source on the premises. House standards are normally kept referenced to national frequency standards via radio broadcasts.

LOCAL STANDARD - A local standard is "local" in the sense that it is not a national standard; hence it may be a house standard or a reference standard or a working standard.

REFERENCE STANDARD, TRANSFER STANDARD - often, the standard used to convey frequency or time from the house standard to working standards (the house standard may itself be considered a reference standard).

WORKING STANDARD - The standard against which instruments are compared for purposes of test or repair.

TIME CODE -

WWV broadcasts (since 1961) a binary-coded-decimal time code (pulse-coded signals) at a 100 pps rate carried on 1000 Hz modulation. WWVB broadcasts (since July 1965) a binary-coded-decimal time code presented by means of a level shift, with markers generated by a 10 dB drop each second. These codes present time-of-year information.

USFS -

United States Frequency Standard, maintained and operated by the Radio Standards Laboratory of the National Bureau of Standards. USFS realizes the idealized Cs resonance frequency to 1 part in 10^{11} .

UT₂ -

Universal Time (UT₀, UT₁, UT₂) is determined by measuring the rotation of the earth. By international agreement, Universal Time is defined as Greenwich Mean Time. For the United States, the U. S. Naval Observatory determines Universal Time. UT₂ means UT corrected for polar motion and for seasonal variation, see Appendix I.

UNCERTAINTY -

Once error has been corrected for, what remains is uncertainty.

APPENDIX VI

HEWLETT-PACKARD INSTRUMENTS FOR FREQUENCY AND TIME STANDARD APPLICATIONS

PRECISION FREQUENCY SOURCES



5060A CESIUM BEAM FREQUENCY STANDARD.

A compact, self-contained primary frequency standard of the atomic beam type, utilizing cesium 133. The cesium beam tube resonator stabilizes the output of a high quality quartz oscillator in a closed loop, continuously monitoring circuit. Accuracy is $\pm 2 \times 10^{-11}$. Outputs are 5 MHz, 1 MHz, 100 kHz sinusoidal; 100 kHz clock drive. Available in either A or UT₂ time scale, or can be easily converted in field. High degree of spectral purity. Two 5060A standards were used in the HP "flying clock" experiment, and were flown around the world to correlate time to 1 μ sec at many timekeeping centers. \$15,500.



106A/B QUARTZ OSCILLATORS.

A 2.5 MHz crystal in this quartz oscillator provides stability of $\pm 5 \times 10^{-11}/24$ hours, and 1.5×10^{-11} max $\Delta f/f$ for averaging times greater than 0.1 sec. Outputs: 5 MHz, 1 MHz, 100 kHz, and a 100 kHz clock drive. Signal-to-noise ratio > 87 dB (5 MHz). Non-harmonically related output < 80 dB. Harmonic distortion < 40 dB. Capable of phase lock operation. The 106B operates from 115/230 V ac power or external 22-30 V dc (see Standby Power Supplies); 106A operates from external 22-30 V dc. 106B also has an internal standby power supply for 8 hours operation without external power. 106A, \$3450, 106B, \$3900.



107AR/BR QUARTZ OSCILLATORS

Performance is similar to Models 106A/B, but have an aging rate of $\pm 5 \times 10^{-10}$ per 24 hours. Model 107AR operates from 22-30 V dc power; Model 107BR operates from 115/230 V ac power and has an internal 2-hour standby battery. They have been prototype-tested to the shock and vibration requirements of MIL-E-16400E specifications. 107AR, \$2400; 107BR, \$2750.

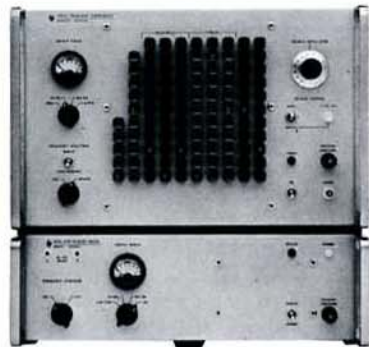

5100A/5110A FREQUENCY SYNTHESIZER

Provides any frequency from 0.01 Hz to 50 MHz selectable in steps as small as 0.01 Hz by 10 rows of manual pushbuttons or by remote electrical commands (20 μ sec switching speed). A voltage-tuned search oscillator varies output as much as 1 MHz with manual or remote control. Retains stability of internal 1 MHz drive signal ($\pm 3 \times 10^{-9}/$ day); or external 1 MHz or 5 MHz standard can be used. Spurious signals are 90 dB below selected frequency. \$15,250.

5102A FREQUENCY SYNTHESIZER

Provides any output frequency from 0.1 Hz to 1 MHz selectable in steps as small as 0.1 Hz, or from 0.01 Hz to 100 kHz in steps as small as 0.01 Hz, by 7 rows of manual pushbuttons or by remote electrical signals (20 μ sec switching speed). Each column can be continuously varied over entire range by local or remote use of the search oscillator. Also provides an output similar to above to which 30 MHz is added. Retains stability of internal 1 MHz source ($\pm 3 \times 10^{-9}/24$ hrs.); or, external 1 MHz or 5 MHz can be used. Spurious signals > 90 dB down, 100 kHz range; > 70 dB down, 1 MHz range. \$6500.



5103A FREQUENCY SYNTHESIZER.

This model is similar to the 5102A except ranges are 1 Hz to 10 MHz (steps as small as 1 Hz) and 0.1 Hz to 1 MHz (steps as small as 0.1 Hz). Spurious signals > 70 dB down, 1 MHz range; > 50 dB down, 10 MHz range. \$7100.

STANDBY POWER SUPPLIES

724BR AND 725AR POWER SUPPLY

Permit continuous operation of HP Frequency Divider and Clock, Quartz Oscillator, or other 24 V dc 500 ma load should ac power fail. Vented nickel-cadmium battery. Charge discharge meters, pilot lamps and alarm relay monitor operation. No switching needed; equipment unaffected by power changeover. Provision for connecting external battery. 724BR, 25 amp-hrs, \$950; less battery, \$600. 725AR, 2 amp-hrs, \$645.



5085A POWER SUPPLY.

Similar to 724BR and 725AR but has greater current capacity to supply standby and/or driving power for HP 5060A Cesium Beam Frequency Standard or entire frequency and time systems. Output: 24 \pm 2 V dc, 2 amps (2.5 amps for 30 minutes). Capacity: 21 ampere-hours. Weight: 75 lbs. \$1250 including battery.



TIME & FREQUENCY INDICATORS & COMPARATORS

114BR TIME COMPARATOR.

Accepts standard input from the HP 115BR Frequency Divider & Clock or HP precision oscillators or other time pulse sources, and facilitates comparison with standard time signal transmissions such as those from station WWV. It uses an oscilloscope as the indicator. Sweep delay range is 0-999 ms in 1 ms steps. Input requirements: 1 kHz and 1 Hz positive pulses (from HP 115BR/CR) and WWV tick; 0.1-10 V peak-to-peak. It is ruggedized and prototype-tested to pass various temperature, vibration, humidity, inclination, and shock tests of Specification MIL-E-16400C. 114BR, \$1200.





115BR/CR FREQUENCY DIVIDER AND CLOCK.

Permits adjustment of local frequency and time standards by making precise comparisons with broadcast standard time and frequency signals. Has in-line mechanical drum display of time (0.01 sec resolution) which is driven from the 100 kHz local time standard (sidereal time on special order). Produces signals to synchronize an external oscilloscope for comparing local standard with WWV tick from external receiver. 115BR is airtight, watertight and environmentally tested to MIL-E-16400C, \$2750. 115CR, for laboratory environment, \$1500.



117A VLF COMPARATOR

Compares phase of received 60 kHz VLF signal (WWVB) to local 100 kHz standard and provides strip chart recording of phase difference. Overall phase stability, $\pm 1 \mu\text{sec}$. Frequency comparison accuracy up to 1×10^{-10} in 8 hours. Sensitivity, $1 \mu\text{v}$. Phase locked 100 kHz output. Chart width, 50 or $16\frac{2}{3} \mu\text{sec}$; speed $1''/\text{hr}$; length, 30 ft. Loop antenna (-60° to $+80^\circ\text{C}$ operating range) and 100 ft. coax lead-in cable included. Is perhaps the most useful single instrument for measuring frequency drift. \$1150. Translator Kit 00117-91027 converts to UT₂ time scale, \$150 (\$175 installed into 117A). K10-117A TRANSLATOR. Converts nominal 100 kHz or 1 MHz signal from atomic interval (the International Second) to UT₂ time scale, or vice-versa. Useful for HP 117A or other purposes. Is supplied with the translation ratio needed for official atomic-to-UT₂ offset in effect at time of purchase. Range: $\pm 1000 \times 10^{-10}$ in steps of 50×10^{-10} . Ratio can be changed in approximately 5 minutes, using accessory gears and motors (nominal additional cost), internal switch for sign reversal. \$800.

ELECTRONIC COUNTERS

HP manufacturers more than 20 different electronic counter models. The two described below are presented as typical solid state models that have proven to be outstanding in popularity and usefulness in working with frequency and time standards.



5245L 50 MHz ELECTRONIC COUNTER AND PLUG-INS.

Measures frequency, multiple and single periods and ratios, scales to 10^9 . Aging rate $3 \times 10^{-9}/24$ hrs (inquire regarding $1 \times 10^{-9}/24$ hrs.). 100 mv sensitivity. 8 digits. BCD output and storage. \$2950.

PLUG-INS.

Converters: 20-100 MHz, \$300; 50-500 MHz, \$500; 300 to 3000 MHz, \$825. Prescaler: dc to 350 MHz, \$685. Video Amp, 1 MV, 50 MHz, \$325. Time Interval, $1 \mu\text{sec}$ - 10^8 sec, \$300. Preset Unit for preset counting, normalizing to engineering units, \$650. Digital Voltmeter, 10-100-1000 V, 0.1% accuracy, \$575.

ACCESSORY.

Transfer oscillator. Measures to 15 GHz. Outstanding versatility, stability, operating ease and certainty. 2590B, \$1900.



5233L, 2 MHz UNIVERSAL COUNTER.

Measures frequency, time interval, period, and single or multiple (to 10^7) periods and ratios. 100 MV sensitivity. Gate times are 10 μ sec to 10 sec. Ac or dc input coupling. Low drift dc differential input amplifiers for accurate trigger point definition from -100 V to +100 V, 6 digits. BCD output and storage. \$1750.

RECORDERS

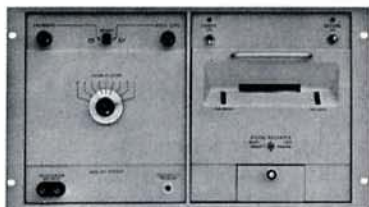

562A DIGITAL RECORDER.

Up to 11 columns of data printing (12 columns, special order) from HP counters, digital voltmeters, etc. 5 lines/sec., max. Plug-in solid-state input modules for parallel entry BCD or 10-line codes. Storage and 2 ms transfer time for BCD inputs. 10-1/2" high, for rack or bench use. \$1600 for 6-column BCD input, \$2053 for 11 columns; typical. Auxiliary analog output to operate recorders, galvanometers, \$175.



MOSELEY 680 STRIP CHART RECORDER.

A solid state device with eight chart speeds, continuous zero set and a zener reference. The 680 uses 6-inch chart paper up to 100 feet long. Eight chart speeds from 1 inch/min to 8 inches/hr. Calibrated spans from 5 mv to 100 V full scale. \$750. Many standard options available.



MOSELEY 7000A X-Y RECORDER.

This is a versatile high sensitivity recorder from HP's Moseley Division. Features include ac or dc inputs, one megohm input resistance, automatic recycling, time sweeps have adjustable length and are usable on either axis, AUTOGRIP® /electric paper holddown for charts 11" x 17" or smaller. Sensitivities are 5 mv/inch ac, 100 mv/inch dc. Ac common-mode rejection 120 dB; dc 140 dB. Slewing speed 20 in./sec. Accuracy: 0.2% full scale dc; 0.5% ac. Repeatability 0.1%. Available in English or metric scales, rack or bench mount. \$2495.

OSCILLOSCOPES

The two instruments detailed below are typical of the eight highly useful HP Oscilloscope models.



120B OSCILLOSCOPE - DC TO 450 KC

Four calibrated vertical ranges, 10 mv/cm to 10 v/cm; 15 calibrated sweeps from 5 μ sec/cm to 200 msec/cm. $\pm 5\%$; x5 sweep magnifier works on all ranges; horizontal amplifier has 3 calibrated steps 100 mv/cm to 10 v/cm. For x-y, phase shift between vertical and horizontal amplifier less than $\pm 2^\circ$ to 100 kc. Beam Finder quickly finds trace. \$495.

175A 50 MHz OSCILLOSCOPE.

Eleven plug-ins extend versatility. Main frame: 6 x 10 cm display, no parallax or defocusing; beam finder; 24 calibrated sweeps, 0.1 μ sec to 5 sec/cm ($\pm 3\%$); x10 magnifier for 10 nsec/cm. Preset internal triggering to over 50 MHz. 1% calibrator. \$1325 without plug-ins.

VERTICAL PLUG-INS

50 MHz DUAL CHANNEL: Chopped or alternate sweeps, 9 calibrated ranges each channel 50 mv/cm up, 7 nsec rise time, sync amplifier for Channel B. \$325. 50 MHz SINGLE CHANNEL: 9 calibrated ranges 50 mv/cm up, 7 nsec rise time, \$160. DIFFERENTIAL: 12 calibrated ranges, 5 mv/cm up, from dc to 19 MHz (to 22 MHz above 50 mv/cm), \$225. WIDE BAND DIFFERENTIAL: dc to 40 MHz, \$285. 40 MHz FOUR CHANNEL: Chopped or alternate sweeps, 9 calibrated ranges, sync amplifiers, \$595. 50 MHz DUAL CHANNEL: Chopped or alternate, 10 calibrated ranges 10 mv/cm up, sync amplifier for Channel B, \$575.

HORIZONTAL PLUG-INS.

AUXILIARY: allows 175A to perform all standard functions, \$25. SWEEP DELAY: 0.5 μ sec to 10 sec, $\pm 0.2\%$ linearity, \$325. DISPLAY SCANNER: for permanent x-y or strip chart recordings. \$425. TIME MARK GENERATOR: for synchronized 0.5% accuracy intensity mod. markers. 10/1/0.1 μ sec intervals, \$130. RECORDER: makes strip chart record of any repetitive 175A display, simply push a button, 20 records for cost of 1 photo, \$775.



MISCELLANEOUS

10511A SPECTRUM GENERATOR.

A passive device that generates a train of 1 nanosec wide pulses when driven by a sinusoidal source. Specifically designed as an HP Frequency Synthesizer accessory; useful with any 50 ohm source from 25 to 50 MHz and 1 to 3 V RMS (input range for useful outputs, 10 to 75 MHz). Available harmonic power - 19 dBm for harmonic 1 to 10. Output extends to 1 GHz region. 3" long, 1-5/8" diameter, \$150.



10514A DOUBLE BALANCED MIXER.

A versatile frequency conversion unit (no tuning required) for mixing, modulating, phase-detecting and level-controlling in 50-ohm systems. A three-port device with input output frequency range of 200 kHz to 500 MHz on two ports and dc to 500 MHz on the third port. Typical 6 dB conversion loss. Low intermodulation products. Useful as a frequency doubler with very flat response at up to 250 MHz input. 2.3" x 0.6" x 2.8", \$250.



10515A FREQUENCY DOUBLER.

Extends usable range of signal generators, frequency synthesizers, and other 50-ohm sources. Input 0.5 to 500 MHz, 0.5 - 3 V RMS, 180 mW, max. Output 1 to 1000 MHz. Frequency response flat to ± 1 dB (typical) over entire range. Undesirable harmonic suppressed more than 25 dB. Insertion loss < 12 dB, < 1 V input; < 13 dB, > 0.5 V input. 2.5" long, 0.7" diam. \$120.





302A WAVE ANALYZER.

Functions as a highly selective tuned voltmeter separating input signal into individual components for evaluation. Direct reading, no calibration required. Frequency range, 20 Hz to 50 kHz. Voltage ranges, 30 μ v to 300 v full scale. Voltage accuracy, 5% of full scale. Residual products and hum > 75 dB down. Selectivity: ± 3.5 Hz bw > 3 dB down; ± 25 Hz bw > 50 dB down; ± 70 Hz bw > 80 dB down, > 70 Hz bw > 80 dB down. \$1800. 297A Sweep Drive (motor) accessory, sweep speed with 302A, 170 and 17 Hz/sec, \$350.



580A and 581A DIGITAL-ANALOG CONVERTERS.

Convert 4-line BCD digital data from HP counters and DVMs to analog dc voltages for strip chart or X-Y recorders. Any three successive digits (or right-hand two) may be chosen for conversion. Transfer time, 1 ms. Accuracy, 0.5%. Potentiometer Output, 100 mv full scale into 20 Kohms. Galvanometer Output, 1 ma full scale into 1500 ohms. 580A, 3-1/2" x 19" for rack or bench, \$525. 581A bench model, 6-1/4" x 8" x 7-25/32", \$525.

Data subject to change without notice

Prices FOB Factory

BIBLIOGRAPHY

ATOMIC TIME AND FREQUENCY STANDARDS

- Wm. Markowitz, "The Atomic Time Scale", IRE Trans. on Instr., p. 239, Dec. 1962.
- G. L. Clark, Ed., "Atomic Frequency Standards", Encyclopedia of Spectroscopy, Reinhold, New York, p. 647, 1960.
- A. O. McCoubrey, "Frequency Control by Microwave Atomic Resonance", The Microwave Journal, Nov. 1961.
- R. C. Mockler, "Atomic Frequency and Time Interval Standards", Radio Science Journal of Research NBS/USNC-URSI Vol. 68D, No. 5, p. 523, May 1964.
- M. Arditi and T. R. Carver, "Atomic Clock Using Microwave Pulse-Coherent Techniques"; IEEE Trans., p. 146, June-Sept. 1964.
- Markowitz, Hall, Essen, and Parry, "Frequency of Cesium in Terms of Ephemeris Time", Physical Review Letters, Vol. 1, No. 3, p. 105, August 1, 1958.
- P. Davidovits, "Optically Pumped Rb-87 Maser Oscillator", Int. Proc. Symp. Definition and Measurement of Short-Term Frequency Stability, (Goddard Space Flight Center), p. III-25, Dec. 1964.
- Peters, Halloway, Bagley, and Cutler, "Hydrogen Maser and Cesium Beam Frequency Standards Comparison", Applied Physics Letters, Vol. 6, No. 2, p. 34, 15 Jan 1965. See also adjacent paper by Peters and Kartsachoff, p. 35.
- F. H. Reder, "Atomic Frequency Control - Achievements and Problems," Frequency, p. 32, July-Aug., 1963.
- F. H. Reder, "Atomic Frequency Standards", Electronics, p. 31, Nov. 23, 1962.
- J. Newman and L. Fey, "A Comparison of Two Independent Atomic Time Scales," Proc. IEEE, Vol. 51, No. 3, March 1963.
- T. C. Anderson and F. G. Merrill, "Crystal-Controlled Primary Frequency Standards: Latest Advances for Long-Term Stability", IRE Trans. on Instr., p. 136, Sept., 1960.
- N. F. Ramsey, "The Atomic Hydrogen Maser," Metrologia, Vol. 1, No. 1, p. 7, Jan. 1965.
- L. N. Cutler, "Examination of Atomic Spectral Lines of a Cs Beam Tube with the HP Frequency Synthesizer", Hewlett-Packard Journal, Vol. 15, No. 4, Dec. 1963.
- G. E. Hudson, "Of Time and the Atom", Physics Today, p. 34, August 1965.
- W. Markowitz, "International Frequency and Clock Synchronization," Frequency, p. 30, July-Aug. 1964.
- J. M. Richardson, "Time and Its Inverse", Int. Science and Technology, June, 1962.
- "From Tuning Forks to Flying Clocks", Report on 19th Annual Frequency Control Symposium, Frequency, p. 6, May-June, 1965.
- G. E. Hudson, "Frequency and Time Standards", Electronics World, August, 1964.
- W. Markowitz, "Time Determination and Distribution - Current Developments and Problems", Proc. Int. Conf. on Chronometry (Lausanne), June 1964.
- "Time Standards", Instruments and Control Systems, Vol. 38, p. 88, October, 1965.

TIMEKEEPING

TIMEKEEPING (Cont'd)

L. N. Bodily, "Correlating Time from Europe to Asia with Flying Clocks", *Hewlett-Packard Journal*, Vol. 16, No. 8, April, 1965.

A. S. Bagley and L. S. Cutler, "A New Performance of the Flying Clock Experiment", *Hewlett-Packard Journal*, Vol. 15, No. 11, July, 1964.

W. Markowitz and C. A. Lidback, "Clock Synchronization via Relay II, Prelim. Report", *Proc. 19th Frequency Control Symposium*.

LF/VLF BROADCASTS, PROPAGATION, AND RECEIVERS

Watt, Plush, Brown, and Morgan, "Worldwide VLF Standard Frequency and Time Signal Broadcasting", *Journal of Research of NBS*, Vol. 65D, No. 6, p. 617, Nov-Dec. 1961.

D. H. Andrews, "LF-VLF Frequency and Time Services of NBS", presented at 19th ISA Conference, New York, October 12-15, 1964, to be published.

D. D. Crombie and A. G. Jean, "The Guided Propagation of ELF and VLF Radio Waves Between the Earth and the Ionosphere", *Journal of Research of NBS*, Vol. 68D, No. 5, p. 584, May 1964.

A. H. Morgan and O. J. Baltzer, "A VLF Timing Experiment", *Radio Science Journal of Research NBS/USNC-URSI*, Vol. 68D, No. 11, p. 1219, Nov. 1964.

R. R. Stone, Jr., "Synchronization of Local Frequency Standards with VLF Transmission", *Proc. 16th Annual Frequency Control Symposium*, p. 227, 1962.

Stone, Markowitz, and Hall, "Time and Frequency Synchronization of Navy VLF Transmissions", *IRE Trans. on Instr.*, p. 155, Sept. 1960.

R. R. Stone and T. H. Gee, "Incorporating FSK into VLF Transmissions", *Frequency*, p. 20, July-Aug., 1964.

L. D. Shapiro, "Loran-C Timing", *Frequency*, p. 32, March-April, 1965.

Doherty, Hefley, and Linfield, "Timing Potentials of Loran-C", *Proc., IRE*, p. 1659, Nov., 1961.

Bates and Albee, "General VLF Phase Variations Observed at College, Alaska", *J. Geophysical Research*, Vol. 70, No. 9, p. 2187, May 1, 1965.

B. E. Blair and A. H. Morgan, "Control of WWV and WWVH Broadcasts by VLF and LF Signals", *Radio Sci. Journal of Research*, Vol. 69D, No. 7, p. 915, July, 1965.

D. Hartke, "A VLF Comparator for Relating Local Frequency Standards", *Hewlett-Packard Journal*, Vol. 16, No. 2, Oct., 1964.

STABILITY AND SPECTRAL PURITY

V. Van Duzer, "Short-Term Stability Measurements," *Int. Proc. Symp. Definition and Measurement of Short-Term Frequency Stability*, Goddard Space Flight Center, Nov. 1964.

L. S. Cutler, "Some Aspects of the Theory and Measurement of Frequency Fluctuations in Frequency Standards," *Ibid.*

J. del Guercio, "How to Measure an Oscillator's Short-Term Stability," *EEE*, p. 80, Nov. 1964.

Baghdady, Lincoln, Nelin, "Short-Term Frequency Stability: Characterization, Theory, and Measurement", p. 704, *IEEE Proc.*, July, 1965.

A special issue that will give extensive coverage to spectral purity is planned for the Feb. 1966 Proceedings of the IEEE.

QUARTZ CRYSTALS

Hammond, Adams, Cutler, "Precision Crystal Units", Frequency, p. 29, July-August 1963.

A. W. Warner, "Design and Performance of Ultraprecise 2.5 Mc Quartz Crystal Units", Bell System Tech. Journal, Vol. 39, p. 1193, Sept. 1960.

FREQUENCY SYNTHESIZERS

V. E. Van Duzer, "A 0-50 Mc Frequency Synthesizer with Excellent Stability, Fast Switching, and Fine Resolution", Hewlett-Packard Journal, Vol. 15, No. 9, May 1964.

R. G. Wicker, "Frequency Synthesizer", G. E. C. Journal, Vol. 32, No. 2, p. 74, 1965.

MEASUREMENT STANDARDS

A. G. McNish, "Measurement Standards", Inter. Sci. & Tech., p. 59, Nov. 1965.

W. A. Wildhack et al, Eds., "Accuracy in Measurements and Calibration, 1965", U. S. Dept. of Commerce, National Bureau of Standards; for sale by the Sup't of Documents, USGPO, Washington, D. C. (20402), price \$1.00.

Measurement Standards Report", a special issue of the ISA Journal, No. 8, February 2, 1961.

ACKNOWLEDGMENTS

This edition of Application Note 52 is a comprehensive revision and expansion of the 1962 edition. It includes many contributions by individuals in the Hewlett-Packard Company Frequency and Time Division. The major portion was compiled by James H. Sheldon and Jane Evans. The special efforts of Lathare N. Bodily, Victor Van Duzer, B. P. Hand, Dexter Hartke, James Marshall and personnel from the National Bureau of Standards and the U.S. Naval Observatory are gratefully acknowledged.

HEWLETT-PACKARD SALES AND SERVICE OFFICES in the United States and Canada

ALABAMA

Huntsville, 35802
2003 Byrd Spring Rd. S.W.
(205) 881-4591
TWX: 510-579-2204

ALASKA

Bellevue, Wash. 98004
11656 N.E. 8th Street
(206) 454-3971
TWX: 910-443-2303

ARIZONA

Scottsdale, 85251
3009 No. Scottsdale Rd.
(602) 945-7601
TWX: 602-949-0111

Tucson, 85716
232 So. Tucson Blvd.
(602) 623-2564
TWX: 602-792-2759

CALIFORNIA

North Hollywood, 91604
3939 Lankershim Blvd.
(213) 877-1282 and 766-3811
TWX: 910-499-2170

Sacramento, 95821
2591 Carlsbad Ave.
(916) 482-1463
TWX: 916-444-8683

San Diego, 92106
1055 Shafter Street
(714) 223-8103
TWX: 714-276-4263

Palo Alto, 94303
1101 Embarcadero Rd.
(415) 327-6500
TWX: 910-373-1280

COLORADO

Englewood, 80110
7965 East Prentice
(303) 771-3455
TWX: 303-771-3056

CONNECTICUT

Middletown, 06458
589 Saybrook Rd.
(203) 346-6611
TWX: 710-428-2036

FLORIDA

Miami, 33125
2907 Northwest 7th St.
(305) 635-6461

Orlando, 32803
621 Commonwealth Ave.
(305) 425-5541
TWX: 305-275-1234

St. Petersburg, 33708
410-150th Ave., Madeira Beach
(813) 391-0211
TWX: 813-391-0666

GEORGIA

Atlanta, 30305
3110 Maple Drive, N.E.
(404) 233-1141
TWX: 810-751-3283

HAWAII

North Hollywood, Calif. 91604
3939 Lankershim Blvd.
(213) 877-1282 and 766-3811
TWX: 910-499-2170

ILLINOIS

Skokie, 60078
5500 Howard Street
(312) 677-0400
TWX: 910-223-3613

INDIANA

Indianapolis, 46205
3919 Meadows Dr.
(317) 546-4891
TWX: 317-635-4300

LOUISIANA

New Orleans
(504) 522-4359

MARYLAND

Baltimore, 21207
6660 Security Blvd.
(301) 944-5400

Rockville, 20852
12303 Twinbrook Pkwy.
(301) 427-7560
TWX: 710-828-9684

MASSACHUSETTS

Burlington, 01804
Middlesex Turnpike
(617) 272-9000
TWX: 710-332-0382

MICHIGAN

Southfield, 48076
24315 Northwestern Hwy.
(313) 353-9100
TWX: 313-357-4425

MINNESOTA

St. Paul, 55114
2459 University Ave.
(612) 646-7881
TWX: 910-563-3734

MISSOURI

Kansas City, 64131
7916 Paseo Street
(816) 444-9494
TWX: 816-556-2423

St. Louis, 63144
2814 South Brentwood Blvd.
(314) 647-4350
TWX: 314-962-3933

NEW JERSEY

Eatontown
(201) 542-0852
Englewood, 07631
391 Grand Avenue
(201) 567-3933

NEW MEXICO

Albuquerque, 87108
6501 Lomas Blvd., N.E.
(505) 255-5586
TWX: 910-989-1655

Las Cruces, 88001
114 S. Water Street
(505) 526-2486
TWX: 505-524-2671

NEW YORK

New York, 10021
236 East 75th Street
(212) 879-2023
TWX: 710-581-4376

Rochester, 14623
39 Saginaw Drive
(716) 473-9500
TWX: 510-253-5981

Poughkeepsie, 12601
82 Washington Street
(914) 454-7330
TWX: 914-452-7425

Syracuse, 13211
5858 East Molloy Rd.
(315) 454-2486
TWX: 710-541-0482

Endicott, 13764
1219 Campville Rd.
(607) 754-0050
TWX: 510-252-0890

NORTH CAROLINA

High Point, 27262
1923 N. Main Street
(919) 882-6873
TWX: 510-926-1516

OHIO

Cleveland, 44129
5579 Pearl Road
(216) 884-9209
TWX: 216-888-0715

Dayton, 45409
1250 W. Dorothy Lane
(513) 298-0351
TWX: 513-944-0090

OKLAHOMA

Oklahoma City
(405) 235-7062

PENNSYLVANIA

Camp Hill
(717) 737-6791
West Conshohocken, 19428
144 Elizabeth Street
(215) 248-1600 and 828-6200
TWX: 215-828-3847

Monroeville, 15146
2545 Moss Side Blvd.
(412) 271-5227
TWX: 710-797-3650

TEXAS

Dallas, 75209
P.O. Box 7166, 3605 Inwood Rd.
(214) 357-1881 and 332-6667
TWX: 910-861-4081

Houston, 77027
P.O. Box 22813, 4242 Richmond Ave
(713) 667-2407
TWX: 713-571-1353

UTAH

Salt Lake City, 84115
1482 Major St.
(801) 486-8166
TWX: 801-521-2604

VIRGINIA

Richmond, 23230
2112 Spencer Road
(703) 282-5451
TWX: 710-956-0157

WASHINGTON

Bellevue, 98004
11656 N. E. 8th St.
(206) 454-3971
TWX: 910-443-2303

GOVERNMENT CONTRACTING OFFICES

Middletown, Pa. 17057
Hewlett-Packard
Contract Marketing Division
Olmsted Plaza
(717) 944-7401
TWX: 717-760-4816

West Conshohocken, Pa. 19428
Hewlett-Packard
Contract Marketing Division
144 Elizabeth Street
(215) 753-1811
TWX: 215-820-3847

CANADA

Montreal, Quebec
Hewlett-Packard (Canada) Ltd.
8270 Mayrand Street
(514) 735-2273
TWX: 610-421-3484

Ottawa, Ontario
Hewlett-Packard (Canada) Ltd.
1762 Carling Avenue
(613) 722-4223
TWX: 610-562-1952

Toronto, Ontario
Hewlett-Packard (Canada) Ltd.
1415 Lawrence Avenue West
(416) 249-9196
TWX: 610-492-2382

Vancouver, B.C.
Hewlett-Packard (Canada) Ltd.
2184 W. Broadway
(604) 738-7520
TWX: 610-922-5059

HEWLETT-PACKARD INTERNATIONAL OFFICES

Electronic Instrument Sales and Service

ARGENTINA

Mauricio A. Saurez
Telecomunicaciones
Carlos Calvo 224, Buenos Aires
Tel: 30-6312

AUSTRALIA

Sample Electronics (Vic.) Pty. Ltd.
9-11 Cremorne Street
Richmond E. 1, Victoria
Tel: 42-4757 (3 lines)
Sample Electronics (N.S.W.) Pty. Ltd.
4 Grose Street, Glebe, N.S.W.
Tel: 69-6338 (6 lines)

AUSTRIA

UNILABOR H.m.b.H.
Wissenschaftliche Instrumente
Rummelhardgasse 6/3
P.O. Box 33, Vienna IX/71
Tel: 42 61 81

BELGIUM

Hewlett-Packard Benelux
20-24 Rue de l'Hopital, Brussels 1
Tel: 11.22.20

BRAZIL

Ciental Importacao e Comercio Ltda.
R. Des Eliseu Guilherme, 62
Sao Paulo 6
Tel: 32-4332

CHILE

Hector Calcagni
Casilla 13942, Santiago
Tel: 6.42.26

COLOMBIA

Instrumentacion Henrik A. Langebeck
& Cia. Ltda.
Apartado Aereo 6287
Bogota 1, D.E.
Tel: 45-78-06
Cable: AARIS - Bogota

DENMARK

Tage Olsen A/S
Ronnegade 1, Copenhagen 0
Tel: 29.48.00

FINLAND

INTO O/Y
P.O. Box 153
11 Meritullinkatu, Helsinki
Tel: 6.11.33

FRANCE

Hewlett-Packard France
150 Blvd. Massena, Paris 13e
Tel: 707.97.19

GERMANY

Hewlett-Packard VgmbH
Steindamm 35, Hamburg 1
Tel: 24.05.51

Hewlett-Packard VgmbH
Kurfürstenstrasse 95
Frankfurt a. Main
Tel: 52.00.36

Hewlett-Packard VgmbH
Reginfriedstrasse 13
Munich 9
Tel: 49.51.21/2

Hewlett-Packard VgmbH
Technisches Büro
Herrenbergerstrasse 110
703 Boblingen, Wurttemberg
Tel: 6971

Hewlett-Packard VgmbH
Lietzenburger Strasse 30
1000 Berlin 30
Tel: 24 92 71

GREECE

K. Karayannis
Klaffmonos Square, Athens 124
Tel: 230.301

INDIA

The Scientific Instrument Company, Ld.
6, Tej Bahadur Sapru Road, Allahabad 1
Tel: 2451

The Scientific Instrument Company, Ld.
240, Dr. Dadabhai Naoroji Rd., Bombay 1
Tel: 26-2642

The Scientific Instrument Company, Ld.
11, Esplanade East, Calcutta 1
Tel: 23-4129

The Scientific Instrument Company, Ld.
30, Mount Road, Madras 2
Tel: 86339

The Scientific Instrument Company, Ld.
B-7, Ajmeri Gate Extn., New Delhi 1
Tel: 271053

IRAN

Telecom Ltd.
P.O. Box 1812, Tehran
Tel: 43850

ISRAEL

Electronics & Engineering Ltd.
16 Kremenetski St., Tel Aviv
Tel: 35021-2-3

ITALY

Hewlett-Packard Italiana S.p.A.
Viale Lunigiana 46, Milan
Tel: 69.15.84/5/6

Hewlett-Packard Italiana S.p.A.
Palazzo Italia
Piazza Marconi, 25, Roma-Eur
Tel: 59.12.544/5

JAPAN

Yokogawa-Hewlett-Packard Ltd.
2270 Ishikawa-cho
Hachioji, Tokyo
Tel: Hachioji 0426-3-1231 (19 lines)

Yokogawa-Hewlett-Packard Ltd.
No. 3, 6-chome, Aoyama-Kitamachi
Akasaka, Minato-ku, Tokyo
Tel: 403-6511

Yokogawa-Hewlett-Packard Ltd.
No. 8, Umeda, Kita-ku, Osaka
Tel: 313-0091

Yokogawa-Hewlett-Packard Ltd.
No. 4, 3-chome, Himeikedori,
Chigusa-ku, Nagoya
Tel: 751-8545

KOREA

American Trading Company, Korea, Ltd.
112-35 Sokong-Dong, Jung-ku
Seoul P.O. Box 1103, Seoul
Tel: 3-7049, 3-7613

NETHERLANDS

Hewlett-Packard Benelux N.V.
23 Burg Roellstraat, Amsterdam W.
Tel: (020) 13.28.98 and 13.54.99

NEW ZEALAND

Sample Electronics (N. Z.) Ltd.
8 Matipo Street
Onehunga S. E. 5, Auckland
Tel: 565-361

NORWAY

Morgenstjerne & Co. A/S
Ingeniørfirma
6 Wessels Gate, Oslo
Tel: 20 16 35

PANAMA

Electronico Balboa, S.A.
P.O. Box 4929
Panama City 5, Panama
Tel: 3-0833

PERU

Fernando Ezeta B.
Casilla 3061
Lima
Tel: 78745

PORTUGAL

TELECTRA
Rua Rodrigo da Fonseca 103
P.O. Box 2531, Lisbon 1
Tel: 68 60 72 and 68 60 73 and 68 60 74

PUERTO RICO & VIRGIN ISLANDS

San Juan Electronics, Inc.
150 Ponce de Leon, Stop 3
P.O. Box 5167
Pta. de Tierra Sta., San Juan 00906
Tel: 725-3342, 724-4406

SPAIN

ATAIO, Ingenieros
Enrique Larreta 12, Madrid 6
Tel: 235.43.44 and 235.43.45

SOUTH AFRICA

F. H. Flanter & Co. (Pty.), Ltd.
Rosella House
Buitencingle Street, Cape Town
Tel: 3-3817

SWEDEN

H-P Instrument AB
Centralvagen 28, Solna, Centrum
Tel: 83.08.30
H-P Instrument AB
Idunagatan 28A
Goteborg
Tel: 27 68 00 and 27 68 01

SWITZERLAND

Max Paul Frey
Wankdorffeldstrasse 66, Berne
Tel: (031) 42.00.78

TAIWAN (FORMOSA)

Hwa Sheng Electronic Co., Ltd.
21 Nanking West Road, Taipei
Tel: 4 6076, 4 5936

TURKEY

TELEKOM Engineering Bureau
P.O. Box 376—Galata, Istanbul
Tel: 49.40.40

UNITED KINGDOM

Hewlett-Packard Ltd.
Dallas Rd., Bedford, England
Tel: Bedford 68052

VENEZUELA

Citec, C. A.
Edif. Arisan-Of #4
Avda. Francisco de Miranda-Chacaito
Apartado del Este 10.837, Caracas
Tel: 71.88.05

YUGOSLAVIA

Belram S.A.
83 Avenue des Mimosas
Brussels 15, Belgium
Tel: 35.29.58

For Sales and Service Assistance in Areas Not Listed Contact:

IN EUROPE

Hewlett-Packard, S. A.
54 Route des Acacias
Geneva, Switzerland
Telephone: (022) 42.81.50
Telex: 2.24.86
Cable: HEWPACKSA

IN LATIN AMERICA

Hewlett-Packard Inter-Americas
1501 Page Mill Road
Palo Alto, California 94304, U.S.A.
Telephone: (415) 326-7000
TWX: 910-373-1267
Telex: 033811 Cable: HEWPACK

ELSEWHERE

Hewlett-Packard
Overseas Sales Department
1501 Page Mill Road
Palo Alto, California 94304, U.S.A.
Telephone: (415) 326-7000
TWX: 910-373-1267
Telex: 033811 Cable: HEWPACK

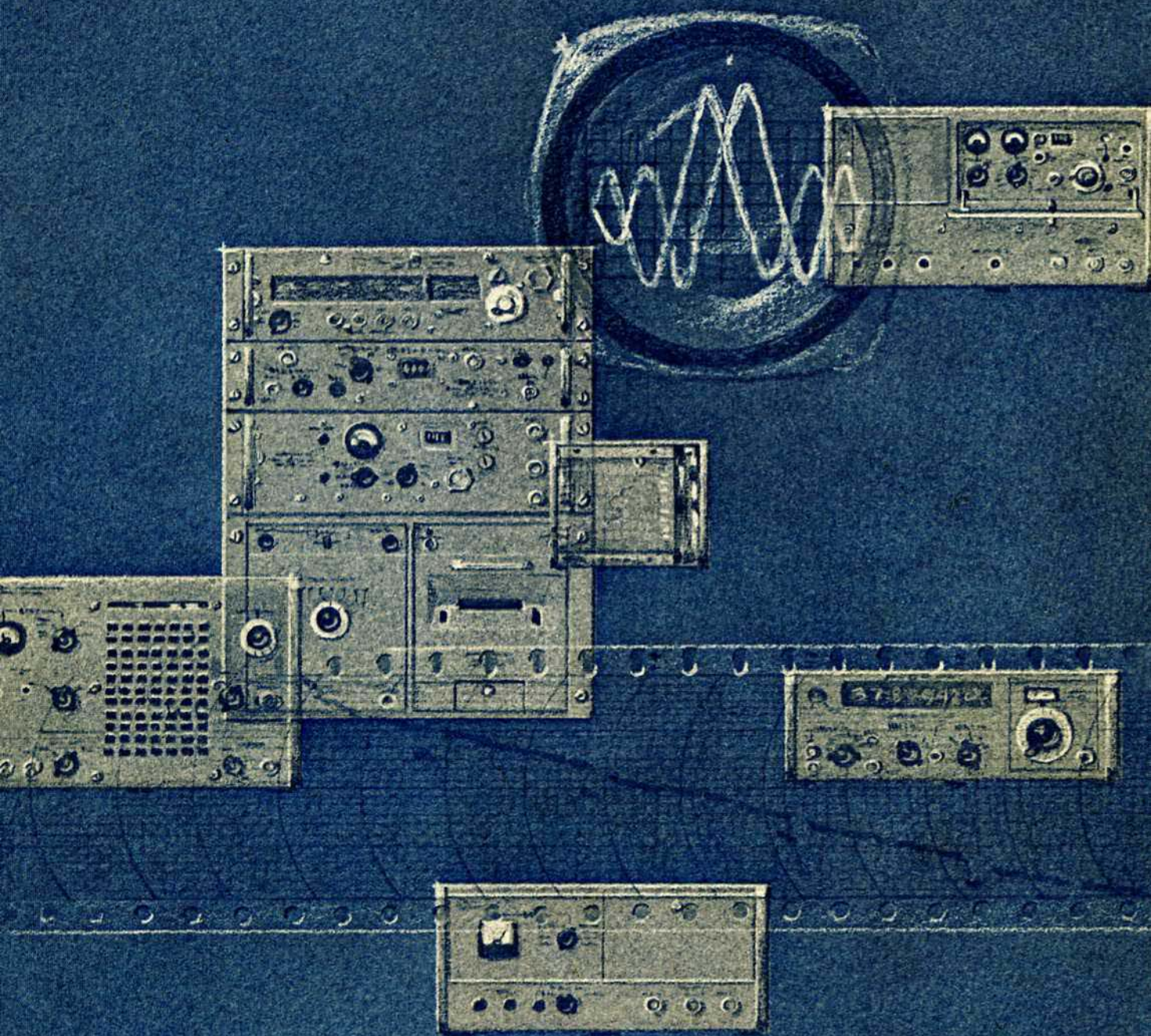

FREQUENCY AND TIME DIVISION, PALO ALTO, CALIFORNIA

HEWLETT  PACKARD